

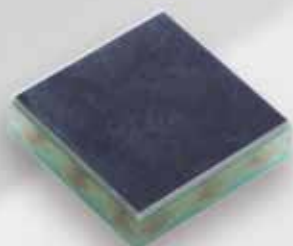

Si Photodiodes

Lineup of Si photodiodes for UV to near IR, radiation



■ CSP type Si photodiode
S10355-01

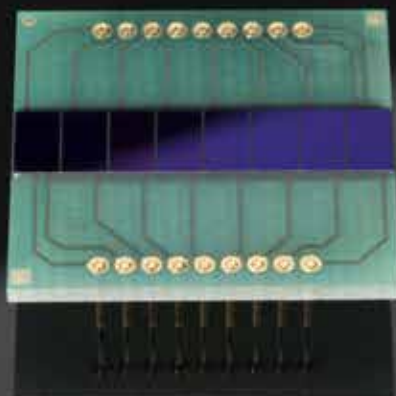

■ 16-element Si photodiode array
S12859-021

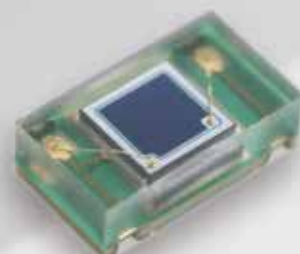

■ Surface mount type Si PIN photodiode
S10993-02CT

Архангельск (8182)63-90-72
Астана (7172)727-132
Астрахань (8512)99-46-04
Барнаул (3852)73-04-60
Белгород (4722)40-23-64
Брянск (4832)59-03-52
Владивосток (423)249-28-31
Волгоград (844)278-03-48
Вологда (8172)26-41-59
Воронеж (473)204-51-73
Екатеринбург (343)384-55-89
Иваново (4932)77-34-06

Ижевск (3412)26-03-58
Иркутск (395)279-98-46
Казань (843)206-01-48
Калининград (4012)72-03-81
Калуга (4842)92-23-67
Кемерово (3842)65-04-62
Киров (8332)68-02-04
Краснодар (861)203-40-90
Красноярск (391)204-63-61
Курск (4712)77-13-04
Липецк (4742)52-20-81
Киргизия (996)312-96-26-47

Магнитогорск (3519)55-03-13
Москва (495)268-04-70
Мурманск (8152)59-64-93
Набережные Челны (8552)20-53-41
Нижний Новгород (831)429-08-12
Новокузнецк (3843)20-46-81
Новосибирск (383)227-86-73
Омск (3812)21-46-40
Орел (4862)44-53-42
Оренбург (3532)37-68-04
Пенза (8412)22-31-16
Казахстан (772)734-952-31

Пермь (342)205-81-47
Ростов-на-Дону (863)308-18-15
Рязань (4912)46-61-64
Самара (846)206-03-16
Санкт-Петербург (812)309-46-40
Саратов (845)249-38-78
Севастополь (8692)22-31-93
Симферополь (3652)67-13-56
Смоленск (4812)29-41-54
Сочи (862)225-72-31
Ставрополь (8652)20-65-13
Таджикистан (992)427-82-92-69

Сургут (3462)77-98-35
Тверь (4822)63-31-35
Томск (3822)98-41-53
Тула (4872)74-02-29
Тюмень (3452)66-21-18
Ульяновск (8422)24-23-59
Уфа (347)229-48-12
Хабаровск (4212)92-98-04
Челябинск (351)202-03-61
Череповец (8202)49-02-64
Ярославль (4852)69-52-93

Contents

■ Packages	5
■ Application examples	8
■ Si photodiodes for precision photometry	9
• For UV to near IR	9
• For UV to near IR (IR sensitivity suppressed type)	11
• For UV monitor	12
• For visible range to near IR	13
■ Si photodiodes for general photometry/visible range	15
• For visible range	15
• For visible range to near IR	16
■ High-speed response Si PIN photodiodes	17
• Cutoff frequency: 1 GHz or more	17
• Cutoff frequency: 100 MHz to less than 1 GHz	18
• Cutoff frequency: 10 MHz to less than 100 MHz	19
■ Multi-element type Si photodiodes	21
• Segmented type Si PIN photodiodes	21
• One-dimensional photodiode arrays (UV to near IR: UV sensitivity enhanced type)	22
■ Surface mount type Si photodiodes	23
• High-speed response Si PIN photodiodes	23
• Segmented type Si photodiodes	23
• Small package type Si photodiodes	24
• Small package type Si PIN photodiodes	24
■ Si photodiodes with preamp, TE-cooled type Si photodiodes	25
• Si photodiodes with preamp for measurement	25
• TE-cooled type Si photodiodes	26
■ Si photodiodes for X-ray detection	27
• Si photodiodes with scintillator	27
• Large area Si PIN photodiodes	29
■ Special application Si photodiodes	31
• RGB color sensors	31
• Violet/blue sensitivity enhanced type	33
• For VUV (vacuum ultraviolet) monitor	34
• For VUV detection (high reliability type)	34
• For monochromatic light detection	35
• For YAG laser detection	35
• Infrared sensitivity enhanced type	36
• For electron beam detector	36
• CSP type	37
• PWB package with leads type	37
■ Related products of Si photodiode	38
• RGB color sensor modules	38
• Color sensor evaluation circuit	38
• Driver circuit for Si photodiode array	39
• Photodiode modules	39
• Signal processing unit for photodiode module	39
• Photosensor amplifier	40
• Charge amplifier	41
■ Description of terms	42
■ Principle of operation, equivalent circuit	43
■ Application circuit examples	44

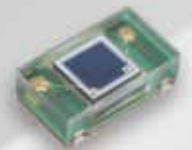
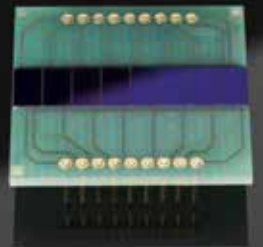
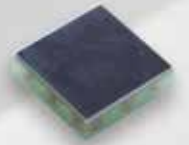

Si photodiodes

Photodiodes are semiconductor light sensors that generate a current or voltage when the P-N junction in the semiconductor is illuminated by light. The term photodiode can be broadly defined to include even solar batteries, but it usually refers to sensors used to detect the intensity of light. Photodiodes can be classified by function and construction as follows:

- Si photodiode
- Si PIN photodiode
- Si APD (avalanche photodiode)

All of these types provide the following features and are widely used for the detection of the presence, intensity and color of light.

- Excellent linearity with respect to incident light
- Low noise
- Wide spectral response range
- Mechanically rugged
- Compact and lightweight
- Long life

Si photodiodes manufactured utilizing our unique semiconductor process technologies cover a broad spectral range from the near infrared to ultraviolet and even to high-energy regions. They also feature high-speed response, high sensitivity and low noise. Si photodiodes are used in a wide range of applications including medical and analytical fields, scientific measurements, optical communications and general electronic products. Si photodiodes are available in various packages such as metal, ceramic and plastic packages as well as in surface mount types. We also offer custom-designed devices to meet special needs.

◆ Hamamatsu Si photodiodes

Type	Feature	Product example
Si photodiode	Featuring high sensitivity and low dark current, these Si photodiodes are specifically designed for precision photometry and general photometry/visible range.	<ul style="list-style-type: none"> • For UV to near IR • For visible range to near IR • For visible range • RGB color sensor • For monochromatic light detection • For VUV (vacuum ultraviolet) detection • For electron beam detector • Infrared sensitivity enhanced type
Si PIN photodiode	Si PIN photodiodes delivering high-speed response when operated with a reverse bias are widely used for optical communications and optical disk pickup, etc.	<ul style="list-style-type: none"> • Cutoff frequency: 1 GHz or more • Cutoff frequency: 100 MHz to less than 1 GHz • Cutoff frequency: 10 MHz to less than 100 MHz • For YAG laser detection
Multi-element type Si photodiode	Si photodiode arrays consist of multiple elements of the same size, formed at an equal spacing in one package. These Si photodiode arrays are used in a wide range of applications such as laser beam position detection and spectrophotometry.	<ul style="list-style-type: none"> • Segment type • One-dimensional type
Si photodiode with preamp, TE-cooled type Si photodiode	Si photodiodes with preamp incorporate a photodiode and a pre-amplifier chip into the same package. Since TE-cooled type Si photodiodes include TE-cooler in a package, they achieve excellent S/N.	<ul style="list-style-type: none"> • For analytical and measurement instrument
Si photodiode for X-ray detection	These detectors are comprised of a Si photodiode coupled to a scintillator. These detectors are used for X-ray baggage inspection and non-destructive inspection.	<ul style="list-style-type: none"> • With scintillator • Large area Si PIN photodiodes
Si APD*	Si APDs are high-speed, high sensitivity photodiodes having an internal gain mechanism.	<ul style="list-style-type: none"> • Near IR type • Short wavelength type • Multi-element type
Related product of Si photodiode	Hamamatsu provides various types of Si photodiode modules.	<ul style="list-style-type: none"> • RGB color sensor module • Color sensor evaluation circuit • Driver circuit for Si photodiode array • Photodiode module • Signal processing unit for photodiode module • Photosensor amplifier • Charge amplifier

* Si APD is not listed in this catalogue.

Note: Hamamatsu also provides PSD (position sensitive detector) used to detect the position of incident light spot. PSD is a non-discrete photosensor utilizing the surface resistance of photodiodes.

Spectral response (typical example)

Hamamatsu provides a lineup that covers a variety of spectral response ranges from 200 nm to 1200 nm.

[S1226/S1336-8BQ, S1227/S1337-1010BR]

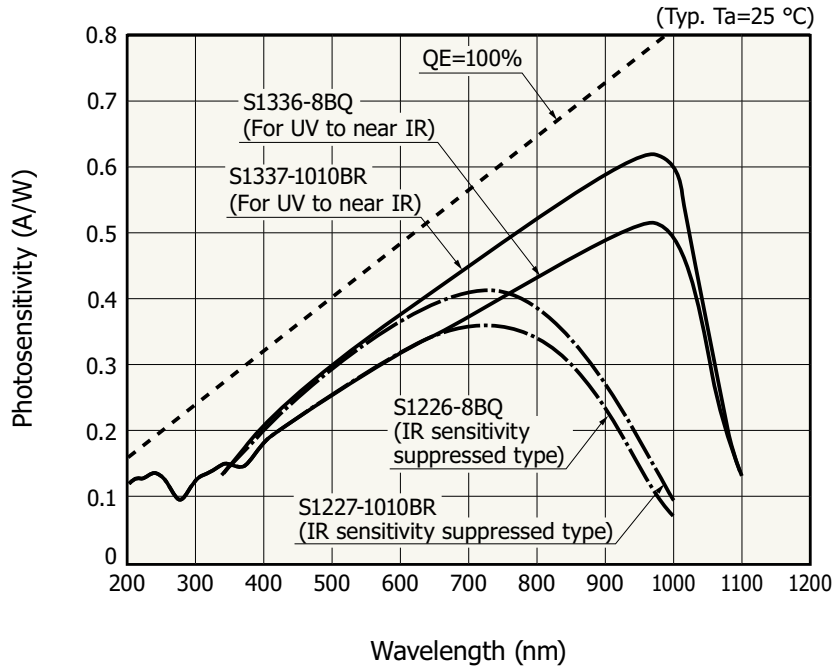

KSPDB0300EC

[S3590-19, S11499, S9219]

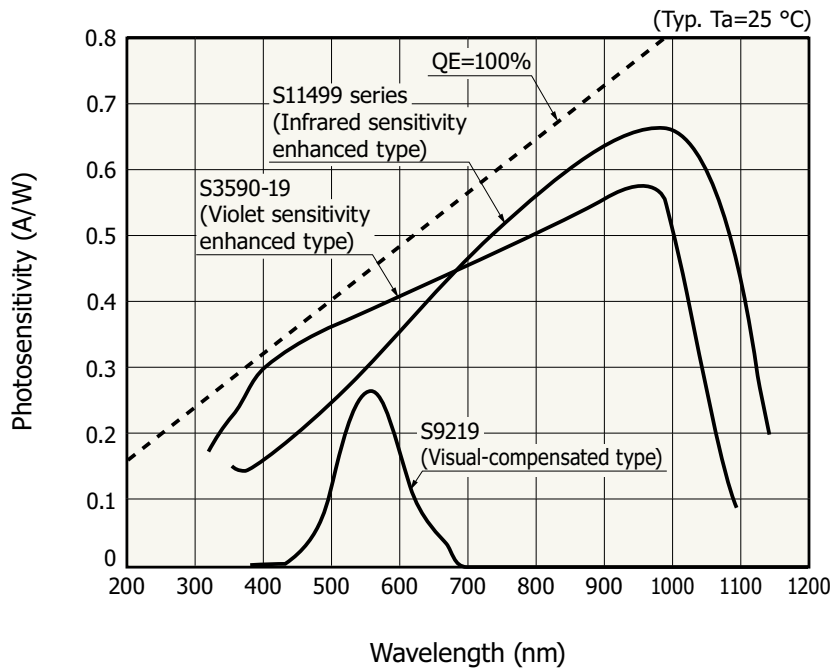

KSPDB0301EB

Packages

Hamamatsu provides a wide variety of packages including metal, ceramic, and plastic.

◆ Si photodiodes for precision photometry

Type	Type no.	Page	Metal	Ceramic	Plastic	Glass epoxy	With BNC connector	Remarks
For UV to near IR	S1336 series	9	Yes					
	S1337 series (excluding S1337-21)	9		Yes				
	S1337-21	10		Yes				Unsealed
	S2551	10		Yes				
	S2281 series	10					Yes	
For UV to near IR (IR sensitivity suppressed type)	S1226 series	11	Yes					
	S1227 series	11		Yes				
	S2281-01	11					Yes	
For UV monitor	S12698 series	12	Yes					
For visible range to near IR	S2386 series	13	Yes					
	S2387 series	14		Yes				

◆ Si photodiodes for general photometry/visible range

Type	Type no.	Page	Metal	Ceramic	Plastic	Glass epoxy	With BNC connector	Remarks	
For visible range	Visual-sensitive compensated	S1087, S1133, S8265	15			Yes			
		S1787-04	15		Yes				
	CIE standard luminous efficiency approximation	S9219	15					Yes	
		S9219-01	15	Yes					
		S7686	15		Yes				
For visible range to near IR	S1787-12, S4797-01 S4011-06DS S1787-08, S2833-01	16			Yes				
	S1133-14, S1087-01 S1133-01	16		Yes					

◆ High-speed response Si PIN photodiodes

Type	Type no.	Page	Metal	Ceramic	Plastic	Glass epoxy	With BNC connector	Remarks
Cutoff frequency: 1 GHz or more	S5973/S9055 series	17	Yes					
Cutoff frequency: 100 MHz to less than 1 GHz	S5971, S3399 S3883, S5972	18	Yes					
	S10783, S10784	18			Yes			
Cutoff frequency: 10 MHz to less than 100 MHz	S6775/S8385/ S8729/S2506 series S6967, S4707-01 S6801-01	19			Yes			
	S5821/S1223 series S3071, S3072 S12271	20	Yes					

◆ Multi-element type Si photodiodes

Type	Type no.	Page	Metal	Ceramic	Plastic	Glass epoxy	With BNC connector	Remarks
Segmented type Si PIN photodiode	S3096-02, S4204, S9345	21			Yes			
	S4349	21	Yes					
One-dimensional photodiode array	S4111/S4114 series	22		Yes				
	S12858/S12859/ S11212/S11299/ S12362/S12363-021	22				Yes		Unsealed

◆ Surface mount type Si photodiodes

Type	Type no.	Page	Metal	Ceramic	Plastic	Glass epoxy	With BNC connector	Remarks
High-speed response Si PIN photodiode	S5106, S5107 S7509, S7510	23		Yes				Surface mount type
Segmented type Si photodiode	S5980, S5981 S5870, S8558	23		Yes				Surface mount type
Small package type Si photodiode	S9674 S10625-01CT	24				Yes		Surface mount type
Small package type Si PIN photodiode	S13773 S10993-02CT S12158-01CT	24				Yes		Surface mount type

◆ Si photodiodes with preamp, TE-cooled type Si photodiodes

Type	Type no.	Page	Metal	Ceramic	Plastic	Glass epoxy	With BNC connector	Remarks
Si photodiode with preamp for measurement	S8745-01, S8746-01 S9295 series	25	Yes					
	S9269, S9270	25		Yes				
TE-cooled type Si photodiode	S2592/S3477 series	26	Yes					

◆ Si photodiodes for X-ray detection

Type	Type no.	Page	Metal	Ceramic	Plastic	Glass epoxy	With BNC connector	Remarks
Si photodiode with scintillator	S8559, S8193	27		Yes				With scintillator
	S12858/S12859/ S11299/S11212/ S12362/S12363 series	27				Yes		With scintillator
Large area type Si PIN photodiode	S3590 series S8650	29		Yes				
	S2744/S3204/ S3584/S3588 series	30		Yes				

◆ Special application Si photodiodes

Type	Type no.	Page	Metal	Ceramic	Plastic	Glass epoxy	With BNC connector	Remarks
RGB color sensor	S7505-01, S9032-02 S9702	31			Yes			Surface mount type
	S10917-35GT S10942-01CT	31				Yes		Surface mount type
	S6428-01, S6429-01 S6430-01	32			Yes			
Violet/blue sensitivity enhanced type	S5973-02, S9195	33	Yes					
	S3994-01	33		Yes				
For VUV (vacuum ultraviolet) monitor	S8552, S8553	34		Yes				Unsealed
For VUV detection (high reliability type)	S10043	34		Yes				Unsealed
For monochromatic light detection	S12742-254	35	Yes					
For YAG laser detection	S3759	35	Yes					
Infrared sensitivity enhanced type	S11499 series, S12028	36	Yes					
For electron beam detector	S11141-10, S11142-10	36		Yes				Unsealed
CSP type	S10356-01, S10355-01	37				Yes		Unsealed
PWB package with leads type	S12497, S12498	37				Yes		Unsealed

Variety of package types

Hamamatsu offers a diverse selection of package types to meet different customer needs. Metal packages are widely used in applications requiring high reliability. Ceramic packages are used for general applications and plastic packages are used in applications where the main need is low cost.

Other types are also available including those with BNC connector, which facilitates connection to coaxial cable, surface mount types that support reflow soldering, and those with scintillator, which converts X-rays and radiation to visible light.

[Metal]



[Ceramic]

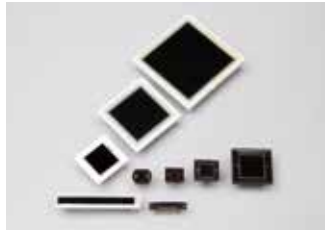

[Plastic]

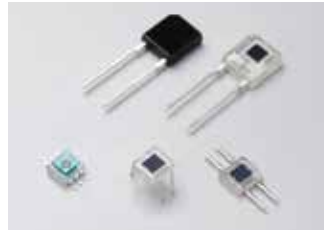

[Glass epoxy]

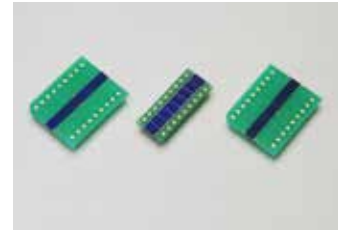

[With BNC connector]



[Surface mount type]

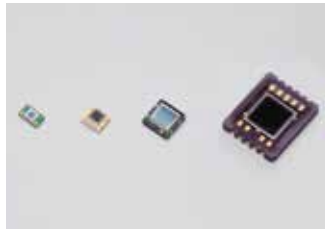

[With scintillator]

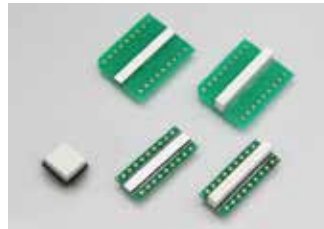

Mount technology

At the Solid State Division of Hamamatsu Photonics, we are constantly at work designing and developing our own mount technology to offer unique semiconductor devices having special features.

Now we will take a brief look at our mount technology for Si photodiodes.

▲ Flip chip bonding

Mounting technology for opto-semiconductors includes not only the two-stage chip die-bonding and wire-bonding but also the flip chip bonding as shown in Figure 1.

Parasitic capacitance and inductance can be a problem when extracting opto-semiconductor device signals from a wire. Flip-chip bonding can prevent this problem and help in downsizing since it utilizes bumps to directly join the chip to the package or an IC chip, etc.

▲ CSP (chip size package)

In CSP type photodiodes, the chip and substrate are connected by bump electrodes so there is minimal dead area on the package surface area. This allows utilizing the photosensitive area more effectively. Also multiple devices can be densely arrayed and used in a tile format. There is no wiring so coupling to the scintillator is easy.

Figure 1 Example of flip chip bonding

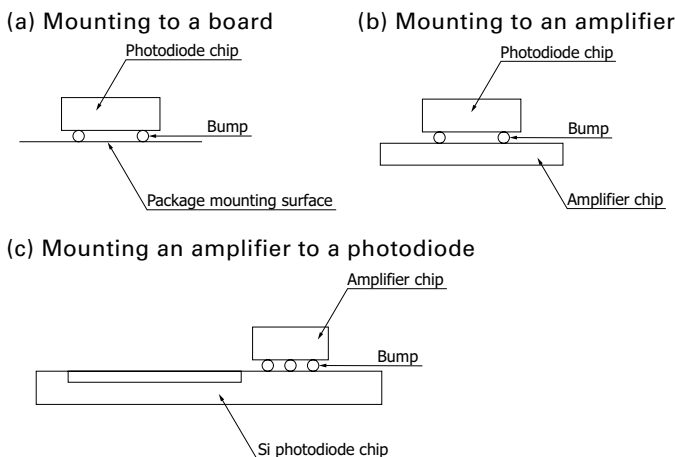
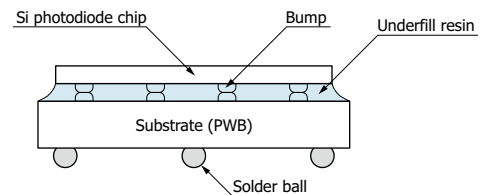

Figure 2 Cross section of CSP type photodiode



KSPDC0065EB

Application examples

Here, we will introduce several applications of our Si photodiodes.

Optical power meters

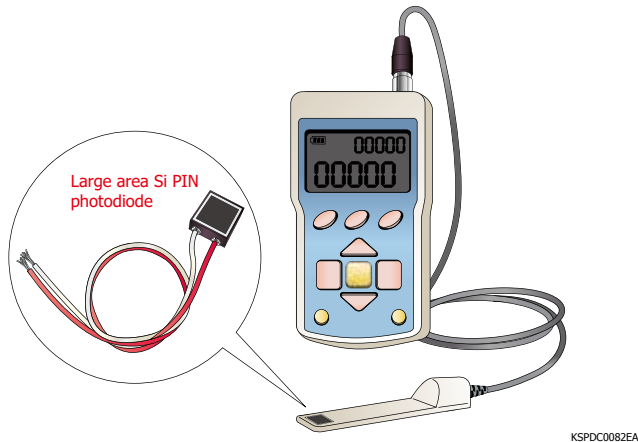

Large area type Si PIN photodiodes are used to measure the light levels of various light sources such as laser diodes and LEDs.

LCD backlight color adjustment

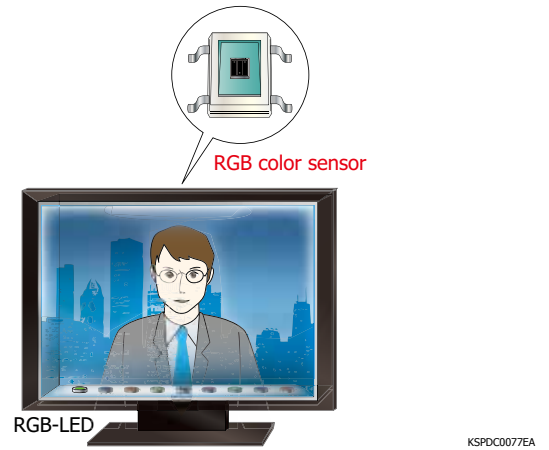

The RGB color sensor detects the white balance of LCD backlight optical waveguides and controls the light level of each RGB LED to stabilize the LCD backlight color.

Sunlight sensors

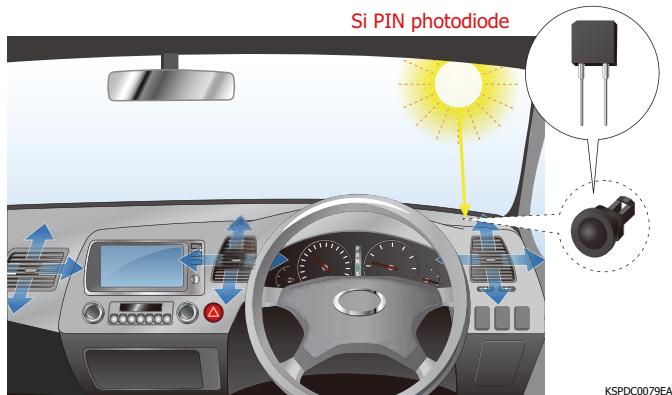

Si photodiodes are used to detect the amount of sunshine to control the volume of air flow for automotive air conditioners.

Spectrophotometers

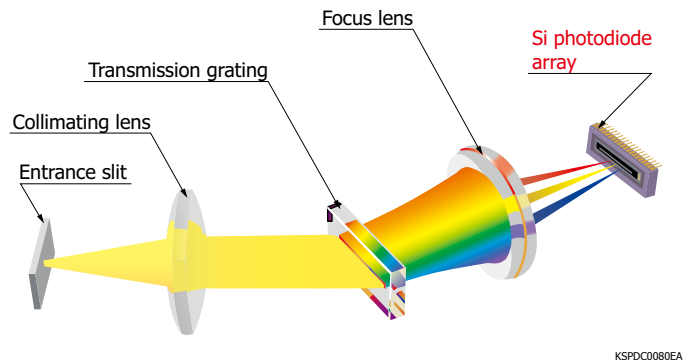

Si photodiode arrays are used to detect light that has been divided into wavelengths through a diffraction grating in spectrophotometers.

Radiation detectors

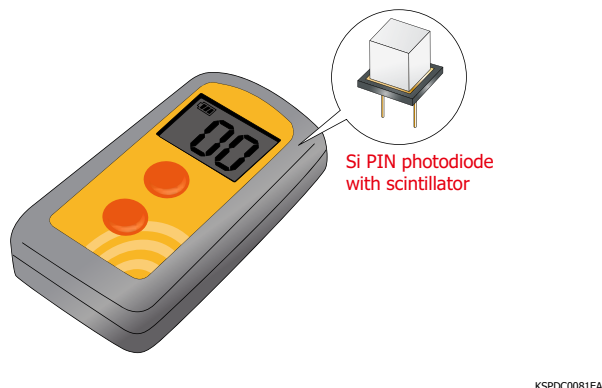

Si PIN photodiodes with scintillators are used in detectors that measure radiation levels of γ rays and other rays.

Baggage inspection equipment

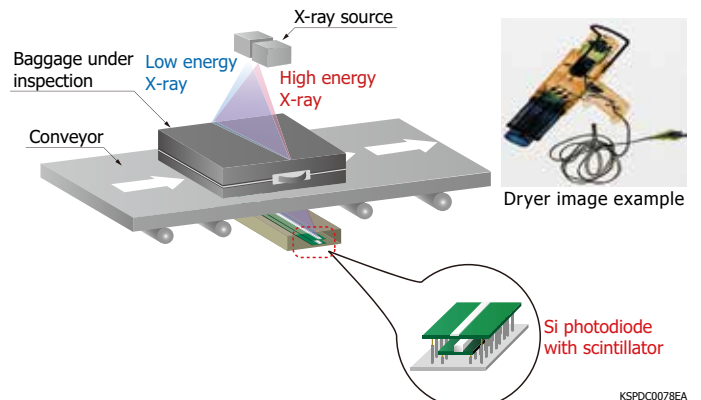





Si PIN photodiodes with scintillators are used in dual energy imaging of baggage inspection equipment to obtain information about an object such as its type and thickness.

Si photodiodes for precision photometry

For UV to near IR

These Si photodiodes have sensitivity in the UV to near IR range. They are suitable for low-light-level detection in analysis and the like. (Typ. Ta=25 °C)

Type no.	Spectral response range (nm)	Photosensitivity (A/W)		Dark current VR=10 mV max. (pA)	Terminal capacitance VR=0 V f=10 kHz (pF)	Photosensitive area size (mm)	Package	Photo				
		λ=200 nm	λ=960 nm									
S1336-18BQ*1	190 to 1100	0.12	0.5	20	20	1.1 × 1.1	TO-18					
S1336-18BK	320 to 1100	-		30	65	2.4 × 2.4	TO-5					
S1336-5BQ*1	190 to 1100	0.12										
S1336-5BK	320 to 1100	-										
S1336-44BQ*1	190 to 1100	0.12										
S1336-44BK	320 to 1100	-										
S1336-8BQ*1	190 to 1100	0.12							100	380	5.8 × 5.8	TO-8
S1336-8BK	320 to 1100	-	50	65	1.1 × 5.9	Ceramic						
S1337-16BQ*1	190 to 1100	0.12						0.5				
S1337-16BR	340 to 1100	-			0.62							
S1337-33BQ*1	190 to 1100	0.12			0.5			30	2.4 × 2.4			
S1337-33BR	340 to 1100	-			0.62							
S1337-66BQ*1	190 to 1100	0.12			0.5			100	380		5.8 × 5.8	
S1337-66BR	340 to 1100	-			0.62							
S1337-1010BQ*1	190 to 1100	0.12			0.5			200	1100		10 × 10	
S1337-1010BR	340 to 1100	-			0.62							

*1: Refer to "Precautions against UV light exposure" (P.48).

Spectral response

[S1336-BQ, S1337-BQ]

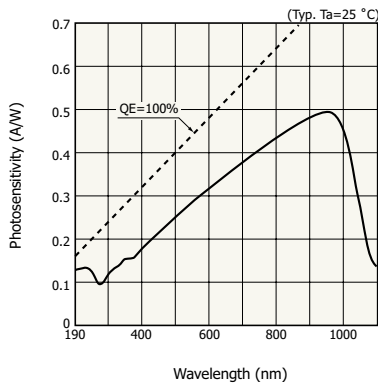

[S1336-BK, S1337-BR]

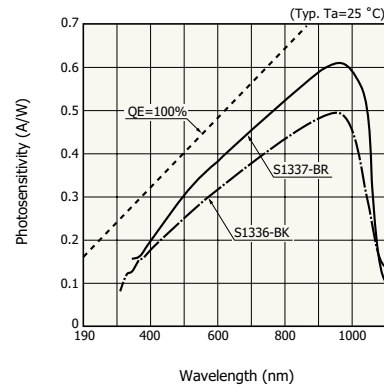

Dark current vs. reverse voltage

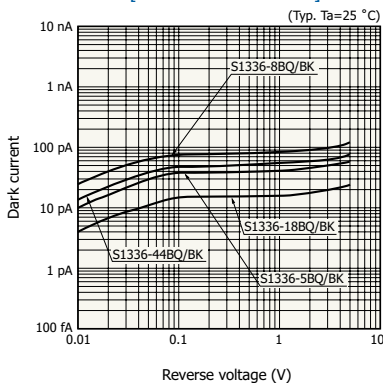

[S1336 series]

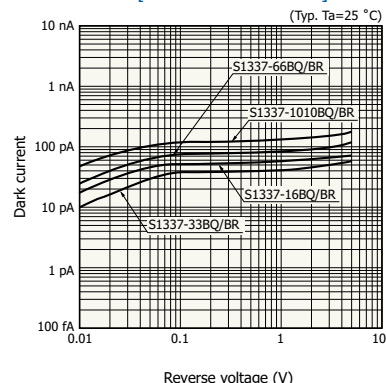

[S1337 series]

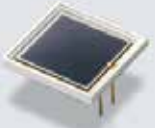

(Typ. Ta=25 °C)

Type no.	Spectral response range (nm)	Photosensitivity (A/W)		Dark current VR=10 mV max. (pA)	Terminal capacitance VR=0 V f=10 kHz (pF)	Photosensitive area size (mm)	Package	Photo
		$\lambda=200$ nm	$\lambda=960$ nm					
S1337-21*2	190 to 1100	0.13	0.52	500	4000	18 × 18	Ceramic (unsealed)	
S2551	340 to 1060	-	0.6 ($\lambda=920$ nm)	1000	350	1.2 × 29.1	Ceramic	
S2281*2 *3	190 to 1100	0.12	0.5	500	1300	$\phi 11.3$	With BNC connector	
S2281-04*2 *3								$\phi 7.98$

*2: Refer to "Precautions against UV light exposure" (P.48).

*3: Connecting a photodiode to the C9329 photosensor amplifier (using a BNC-BNC coaxial cable E2573) allows amplifying the photodiode's weak photocurrent with low noise.

Spectral response

[S1337-21]

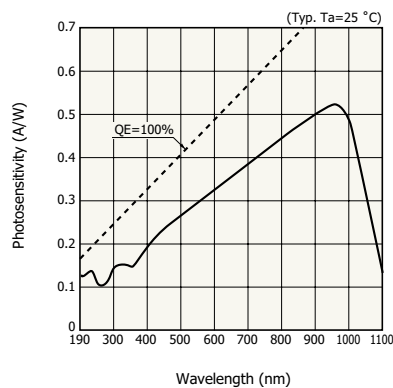

KSPDB0304EA

[S2551]

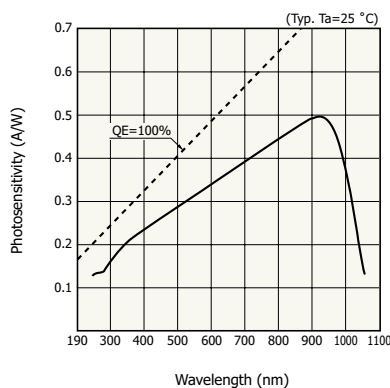

KSPDB0173EB

[S2281, S2281-04]

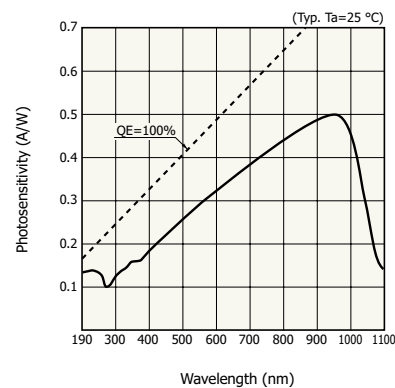

KSPDB0270EA

Dark current vs. reverse voltage

[S1337-21]

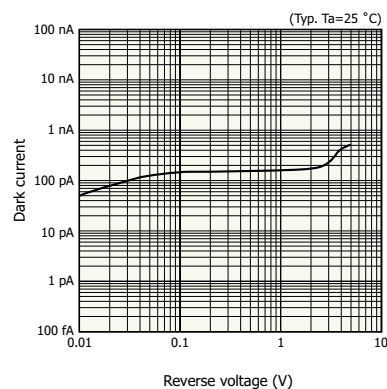

KSPDB0305EA

[S2551]

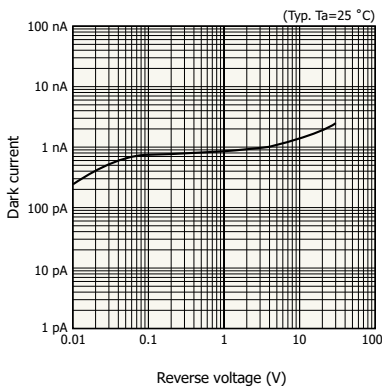

KSPDB0175EB

[S2281, S2281-04]

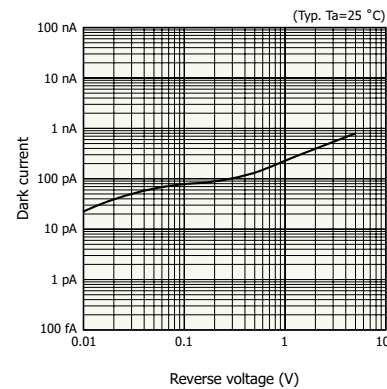









KSPDB0271EB

For UV to near IR (IR sensitivity suppressed type)

These Si photodiodes have suppressed IR sensitivity. They are suitable for low-light-level detection in analysis and the like.

(Typ. Ta=25 °C)

Type no.	Spectral response range (nm)	Photosensitivity (A/W)		Dark current VR=10 mV max. (pA)	Terminal capacitance VR=0 V f=10 kHz (pF)	Photosensitive area size (mm)	Package	Photo
		λ=200 nm	λ=720 nm					
S1226-18BQ*1	190 to 1000	0.12	0.36	2	35	1.1 × 1.1	TO-18	
S1226-18BK	320 to 1000	-						
S1226-5BQ*1	190 to 1000	0.12		5	160	2.4 × 2.4	TO-5	
S1226-5BK	320 to 1000	-						
S1226-44BQ*1	190 to 1000	0.12		10	500	3.6 × 3.6	TO-5	
S1226-44BK	320 to 1000	-						
S1226-8BQ*1	190 to 1000	0.12		20	1200	5.8 × 5.8	TO-8	
S1226-8BK	320 to 1000	-						
S1227-16BQ*1	190 to 1000	0.12	0.36	5	170	1.1 × 5.9	Ceramic	
S1227-16BR	340 to 1000	-						
S1227-33BQ*1	190 to 1000	0.12	0.36	20	950	5.8 × 5.8	Ceramic	
S1227-33BR	340 to 1000	-						
S1227-66BQ*1	190 to 1000	0.12	0.36	50	3000	10 × 10	Ceramic	
S1227-66BR	340 to 1000	-						
S1227-1010BQ*1	190 to 1000	0.12	0.36	300	3200	φ11.3	With BNC connector	
S1227-1010BR	340 to 1000	-						

*1: Refer to "Precautions against UV light exposure" (P.48).

Spectral response

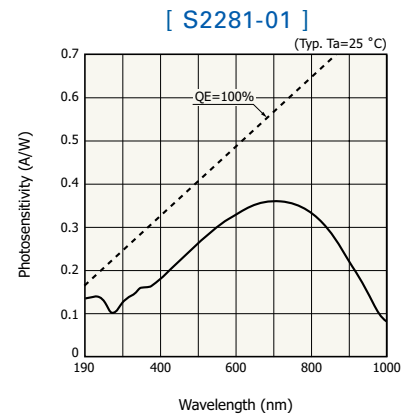
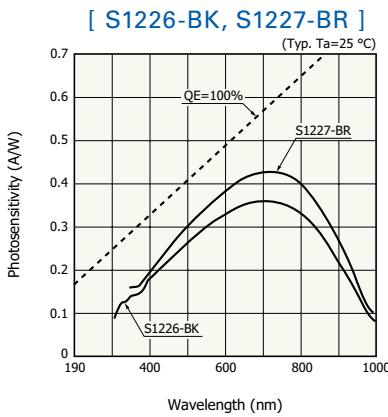
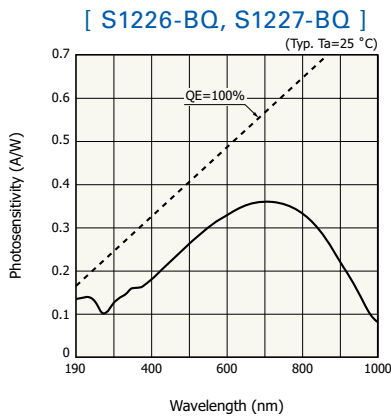

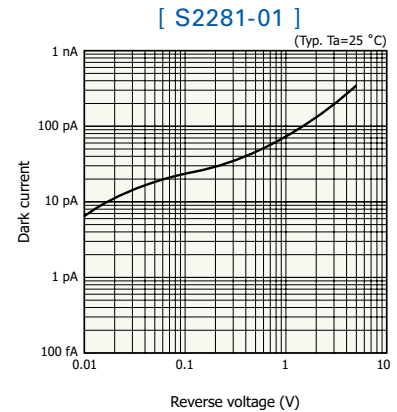
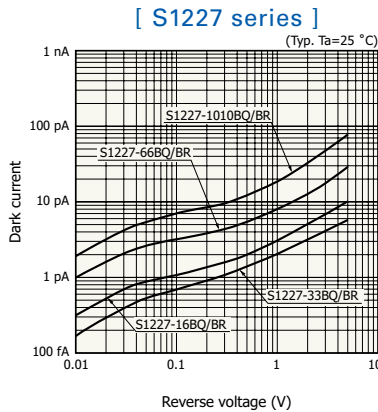
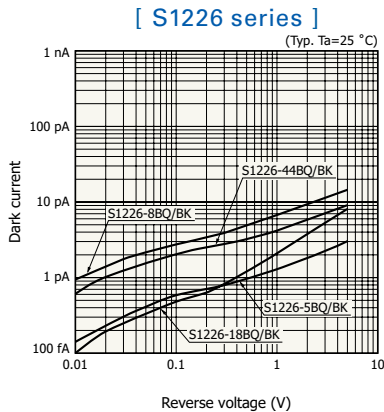

Dark current vs. reverse voltage





For UV monitor

The S12698 series are Si photodiodes that have achieved high reliability for monitoring ultraviolet light by employing a structure that does not use resin. They exhibit low sensitivity deterioration under UV light irradiation and are suitable for applications such as monitoring intense UV light sources. (Typ. Ta=25 °C)

Type no.	Photosensitivity $\lambda=\lambda_p$ (A/W)	Dark current $V_R=10\text{ mV}$ max. (pA)	Photosensitive area size (mm)	Package	Photo
S12698*2	0.38	10	1.1 × 1.1	TO-18	
S12698-01*2		30	2.4 × 2.4	TO-5	
S12698-02*2		100	5.8 × 5.8	TO-8	

*2: Refer to "Precautions against UV light exposure ①" (P.48).

Spectral response

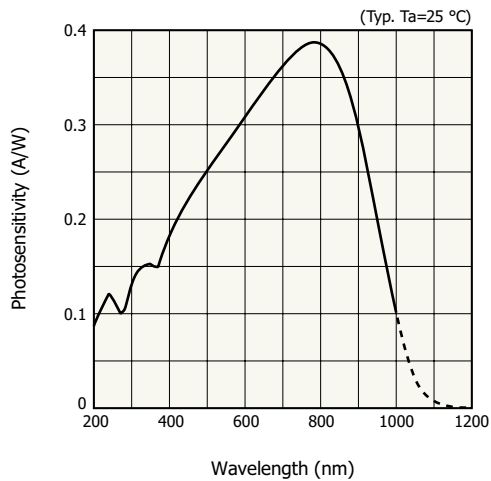

KSPD80350EA

Changes in spectral response after irradiated with UV light

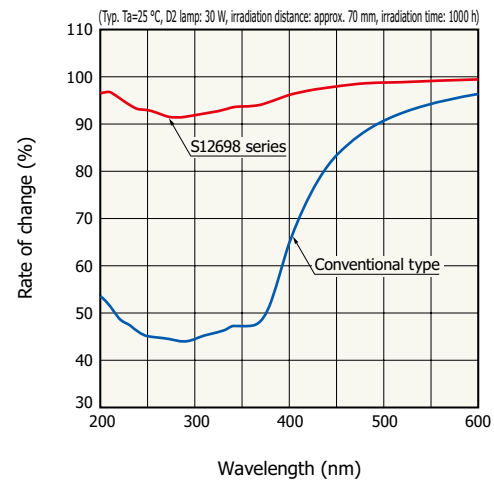



KSPD80355EA

For visible range to near IR

These Si photodiodes offer enhanced sensitivity especially in the near IR range.

(Typ. $T_a=25\text{ }^\circ\text{C}$)

Type no.	Spectral response range (nm)	Photosensitivity $\lambda=960\text{ nm}$ (A/W)	Dark current $V_R=10\text{ mV}$ max. (pA)	Terminal capacitance $V_R=0\text{ V}$ $f=10\text{ kHz}$ (pF)	Photosensitive area size (mm)	Package	Photo
S2386-18K	320 to 1100	0.6	2	140	1.1×1.1	TO-18	
S2386-18L							
S2386-5K			TO-5	5	730	2.4×2.4	
S2386-44K				20	1600	3.6×3.6	
S2386-45K				30	2300	3.9×4.6	
S2386-8K				50	4300	5.8×5.8	

Spectral response

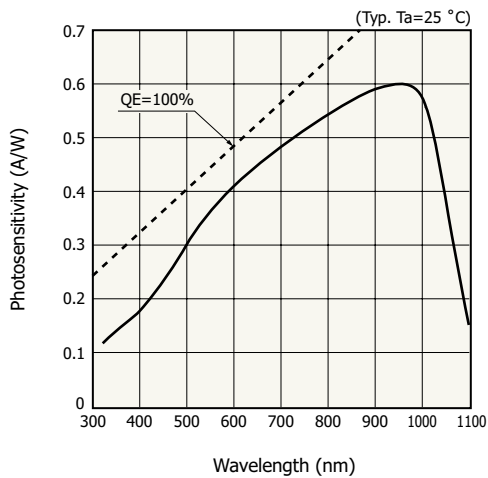

KSPDB0272EE



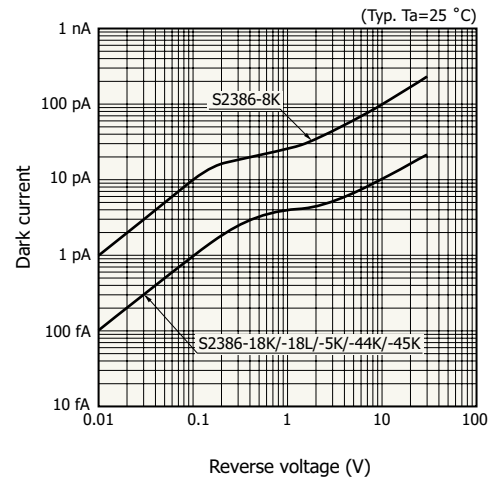

Dark current vs. reverse voltage



KSPDB0113EE



(Typ. Ta=25 °C)

Type no.	Spectral response range (nm)	Photosensitivity $\lambda=960$ nm (A/W)	Dark current $V_R=10$ mV max. (pA)	Terminal capacitance $V_R=0$ V $f=10$ kHz (pF)	Photosensitive area size (mm)	Package	Photo
S2387-16R	340 to 1100	0.58	5	730	1.1 × 5.9	Ceramic	
S2387-33R					2.4 × 2.4		
S2387-66R			5.8 × 5.8				
S2387-1010R			10 × 10				
S2387-130R			1.2 × 29.1				

Spectral response

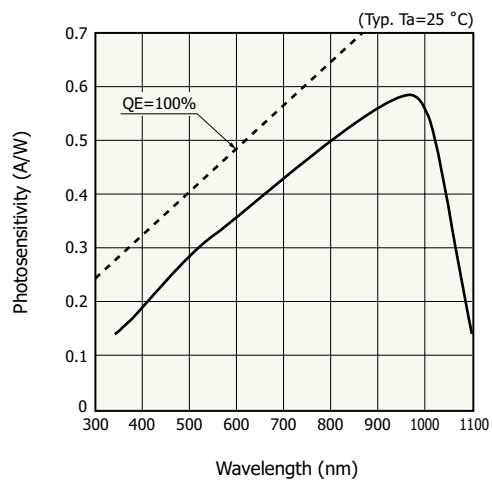

KSPD80356EA

Dark current vs. reverse voltage

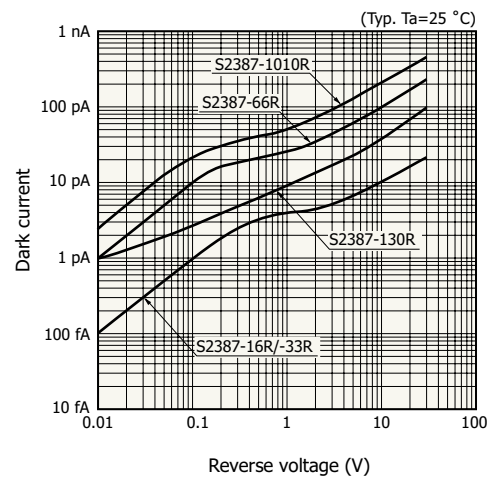

KSPD80117EC

Si photodiodes for general photometry/visible range

For visible range





These Si photodiodes have sensitivity in the visible range.

(Typ. $T_a=25\text{ }^\circ\text{C}$)



Type no.	Spectral response range (nm)	Peak sensitivity wavelength (nm)	Photosensitivity $\lambda=\lambda_p$ (A/W)	Dark current $V_R=1\text{ V}$ max. (pA)	Photosensitive area size (mm)	Package	Photo
----------	------------------------------	----------------------------------	--------------------------------------------	-----------------------------------------	-------------------------------	---------	-------

Filter type (general use)

These are Si photodiodes with visible-compensated filters. The S8265 is a high humidity resistance type of the S1133.

S1087	320 to 730	560	0.3	10	1.3 × 1.3	Ceramic	
S1133					2.4 × 2.8		
S8265	340 to 720	540		20	2.4 × 2.8	Ceramic	
S1787-04	320 to 730	560		10	2.4 × 2.8	Plastic	

Filter type (CIE spectral luminous efficiency approximation)

S9219	380 to 780	550	0.24	500 ($V_R=10\text{ mV}$)	$\phi 11.3$	With BNC connector	
S9219-01			0.22	50 ($V_R=10\text{ mV}$)	3.6 × 3.6	TO-5	
S7686	480 to 660		0.38	20	2.4 × 2.8	Ceramic	

Spectral response

[S1087, S1133, S1787-04, S8265]

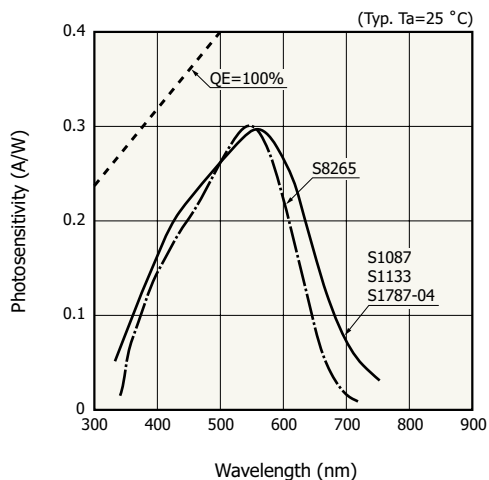

KSPD80277EC

[S9219 series, S7686]

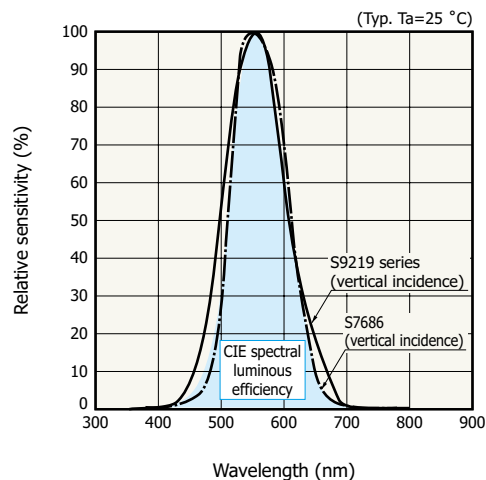









KSPD80285ED



For visible range to near IR

These Si photodiodes have sensitivity in the visible range to near IR.

(Typ. $T_a=25\text{ }^\circ\text{C}$)

Type no.	Spectral response range (nm)	Peak sensitivity wavelength (nm)	Photosensitivity $\lambda=\lambda_p$ (A/W)	Dark current $V_R=1\text{ V max.}$ (pA)	Photosensitive area size (mm)	Package	Photo
S1787-12	320 to 1000	650	0.35	20	2.4×2.8	Plastic	
S4797-01		720	0.4		1.3×1.3		
S1133-14					Ceramic	2.4×2.8	
S4011-06DS	320 to 1100	960	0.58	10	1.3×1.3	Plastic	
S1787-08					2.4×2.8		
S2833-01							
S1087-01					1.3×1.3	Ceramic	
S1133-01					2.4×2.8		

Spectral response

[S1787-12, S4797-01, S1133-14]

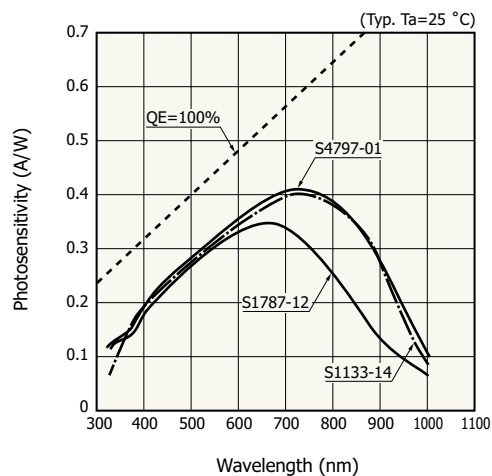



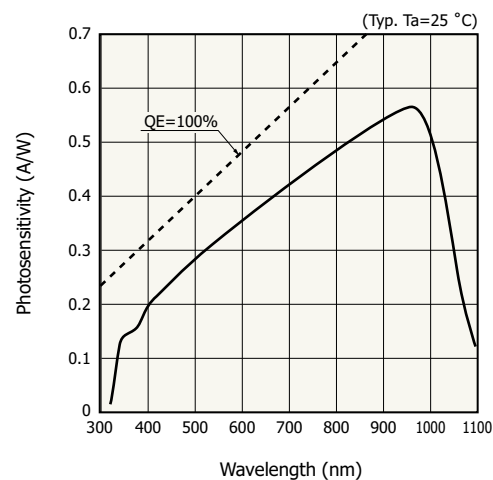

[S4011-06DS, S1787-08, S2833-01, S1087-01, S1133-01]



High-speed response Si PIN photodiodes

Cutoff frequency: 1 GHz or more

These Si PIN photodiodes deliver a wide bandwidth even with a low bias, making them suitable for high-speed photometry as well as optical communications. (Typ. $T_a=25\text{ }^\circ\text{C}$)

Type no.	Cutoff frequency (GHz)	Photosensitive area size (mm)	Photosensitivity (A/W)		Terminal capacitance $f=1\text{ MHz}$ (pF)	Package	Photo
			$\lambda=780\text{ nm}$	$\lambda=830\text{ nm}$			
S5973	1 ($V_R=3.3\text{ V}$)	$\phi 0.4$	0.51	0.47	1.6 ($V_R=3.3\text{ V}$)	TO-18	
S5973-01							
S9055	1.5 ($V_R=2\text{ V}$)	$\phi 0.2$	0.35	0.25	0.8 ($V_R=2\text{ V}$)		
S9055-01	2 ($V_R=2\text{ V}$)				0.5 ($V_R=2\text{ V}$)		

Spectral response

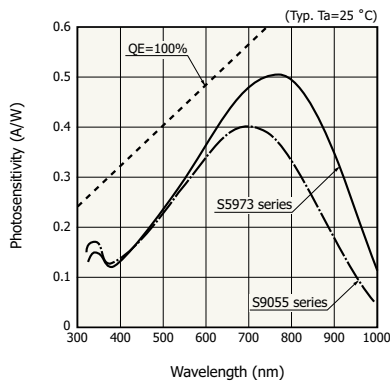

Terminal capacitance vs. reverse voltage

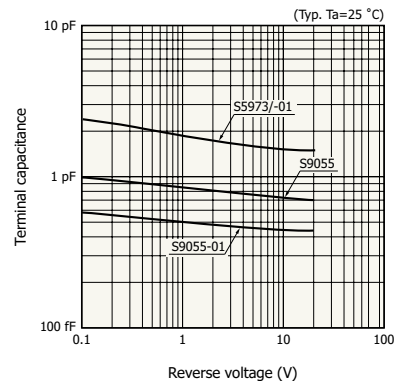

Frequency response

[S5973, S5973-01]

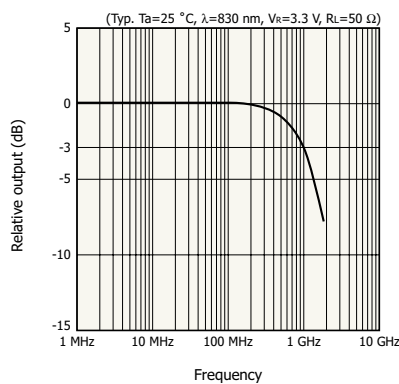

[S9055 series]

$\lambda=410\text{ nm}$

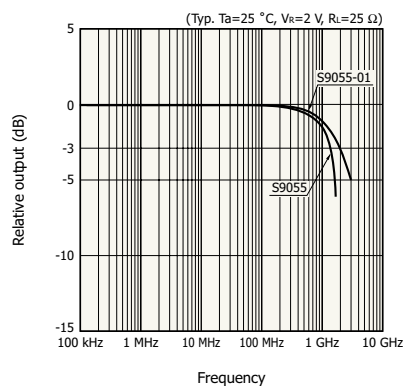



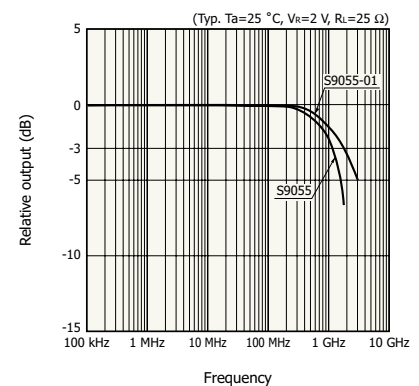

$\lambda=830\text{ nm}$



Cutoff frequency: 100 MHz to less than 1 GHz

These Si PIN photodiodes have a large photosensitive area ($\phi 0.8$ to $\phi 3$ mm) yet deliver excellent frequency response characteristics.

(Typ. $T_a=25^\circ\text{C}$)

Type no.	Cutoff frequency (MHz)	Photosensitive area size (mm)	Photosensitivity (A/W)		Terminal capacitance f=1 MHz (pF)	Package	Photo
			$\lambda=660$ nm	$\lambda=780$ nm			
S5971	100 ($V_R=10$ V)	$\phi 1.2$	0.44	0.55	3 ($V_R=10$ V)	TO-18	
S3399		$\phi 3$	0.45	0.58	20 ($V_R=10$ V)		
S3883	300 ($V_R=20$ V)	$\phi 1.5$			6 ($V_R=20$ V)	TO-5	
S10783	300 ($V_R=2.5$ V)	$\phi 0.8$	0.46	0.52	4.5 ($V_R=2.5$ V)		Plastic
S10784		$\phi 3$	0.45	0.51		Plastic with lens	
S5972	500 ($V_R=10$ V)	$\phi 0.8$	0.44	0.55	3 ($V_R=10$ V)	TO-18	

Spectral response

[S5971, S3399, S3883]

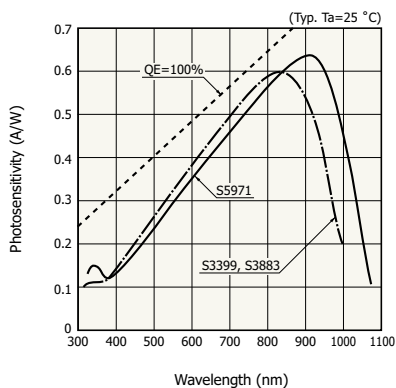

KPINB0316EC

[S10783, S10784]

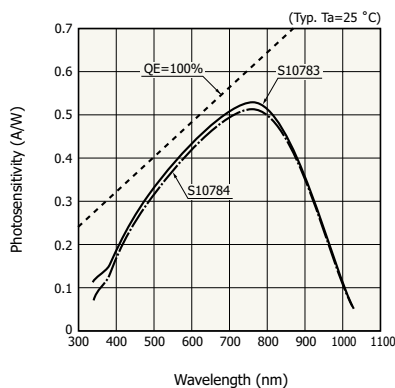

KPINB0355EC

[S5972]

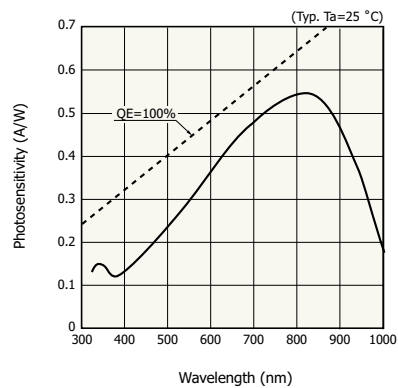

KPINB0315ED

Terminal capacitance vs. reverse voltage

[S5971, S3399, S3883]

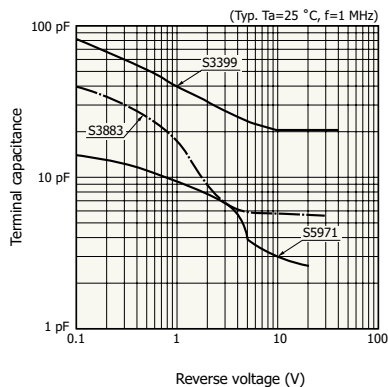

KPINB0341EC

[S10783, S10784]

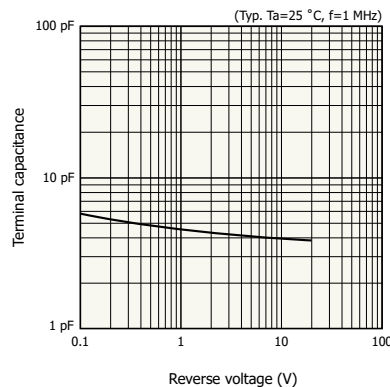

KPINB0358EC

[S5972]

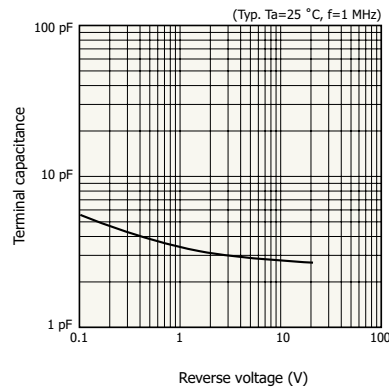











KPINB0338EB

Cutoff frequency: 10 MHz to less than 100 MHz

A wide variety of types are provided including a low-cost plastic package type and visible-cut type.

(Typ. Ta=25 °C)

Type no.	Cutoff frequency (MHz)	Photosensitive area size (mm)	Photosensitivity (A/W)		Terminal capacitance f=1 MHz (pF)	Package	Photo
			$\lambda=660$ nm	$\lambda=780$ nm			
S6775	15 (VR=10 V)	5.5 × 4.8	0.45	0.55	40 (VR=10 V)	Plastic	
S6967	50 (VR=10 V)				50 (VR=10 V)		
S6775-01	15 (VR=10 V)		0.54 ($\lambda=830$ nm)	0.68 ($\lambda=\lambda_p$)	40 (VR=10 V)		
S8385	25 (VR=5 V)	2 × 2	0.4	0.48	12 (VR=5 V)		
S8385-04			0.44 ($\lambda=830$ nm)	0.56 ($\lambda=\lambda_p$)			
S8729		2 × 3.3	0.45	0.55	16 (VR=5 V)		
S8729-04			0.52 ($\lambda=830$ nm)	0.68 ($\lambda=\lambda_p$)			
S8729-10			0.45	0.55			
S2506-02		25 (VR=12 V)	2.77 × 2.77	0.4	0.48		15 (VR=12 V)
S2506-04	0.25 ($\lambda=830$ nm)			0.56 ($\lambda=\lambda_p$)			
S4707-01	20 (VR=10 V)	2.4 × 2.8	0.4	0.48	14 (VR=10 V)		
S6801-01	15 (VR=10 V)	$\phi 14$ (lens diameter)	0.52 ($\lambda=830$ nm)	0.65 ($\lambda=\lambda_p$)	50 (VR=10 V)	Plastic with $\phi 14$ mm lens 	

Spectral response

[S8385/S8729 series]

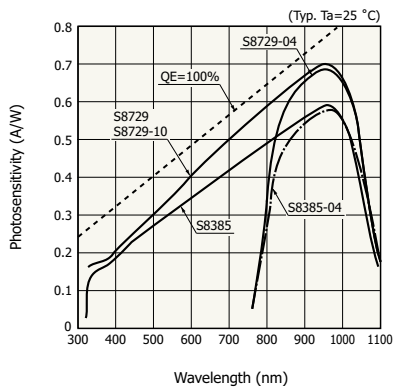

KPINB0324EE

[S6775/S6967/S2506 series]

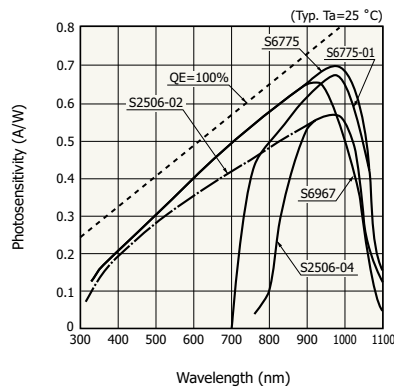





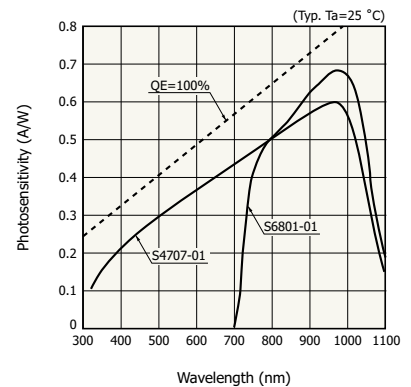



KPINB0167EG

[S4707-01, S6801-01]



KPINB0354EB

(Typ. Ta=25 °C)

Type no.	Cutoff frequency (MHz)	Photosensitive area size (mm)	Photosensitivity (A/W)		Terminal capacitance f=1 MHz (pF)	Package	Photo
			$\lambda=660$ nm	$\lambda=780$ nm			
S5821	25 (VR=10 V)	$\phi 1.2$	0.45	0.52	3 (VR=10 V)	TO-18	
S5821-02							
S5821-01							
S5821-03							
S1223	30 (VR=20 V)	2.4 × 2.8	0.45	0.52	10 (VR=20 V)	TO-5	
S1223-01	20 (VR=20 V)	3.6 × 3.6			20 (VR=20 V)		
S3072	45 (VR=24 V)	$\phi 3$	0.47	0.54	7 (VR=24 V)	TO-8	
S3071	40 (VR=24 V)	$\phi 5$			18 (VR=24 V)		
S12271*	60 (VR=100 V)	$\phi 4.1$	0.5 ($\lambda=960$ nm)		10 (VR=100 V)		

* Refer to "Precautions against UV light exposure" (P.48).

Spectral response

[S5821 series, S3071, S3072]

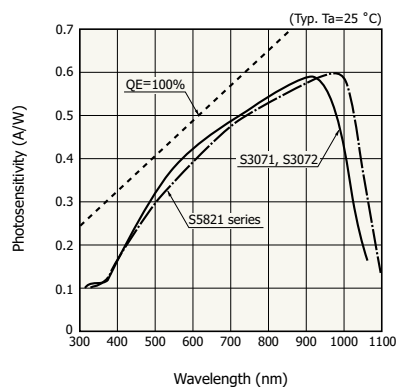

KPINB0335EB

[S1223 series]

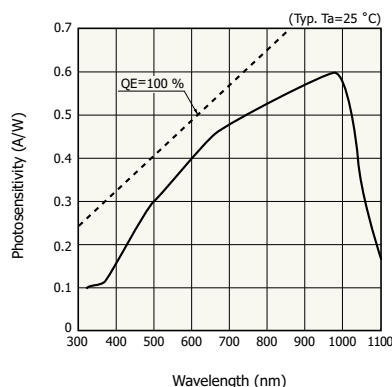

KPINB0143EB

[S12271]

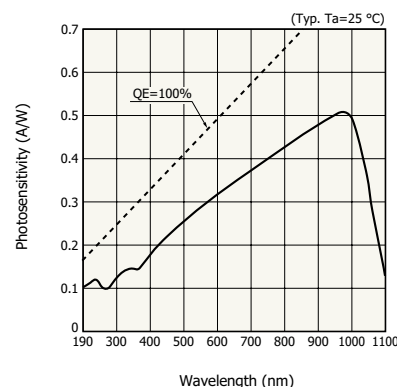

KPINB0386EB

Terminal capacitance vs. reverse voltage

[S5821 series, S3071, S3072]

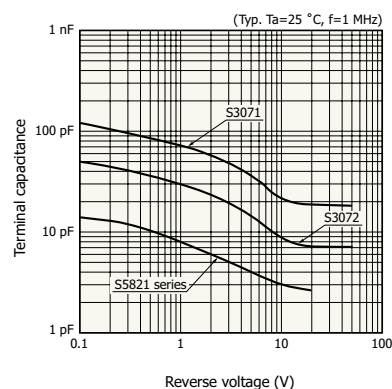

KPINB0344EA

[S1223 series]

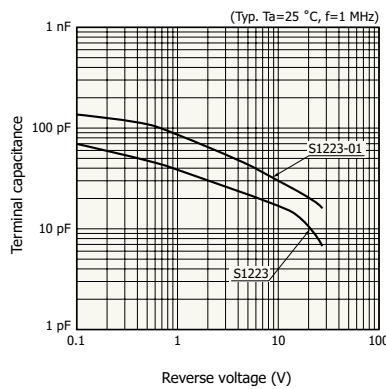

KPINB0146EA

[S12271]

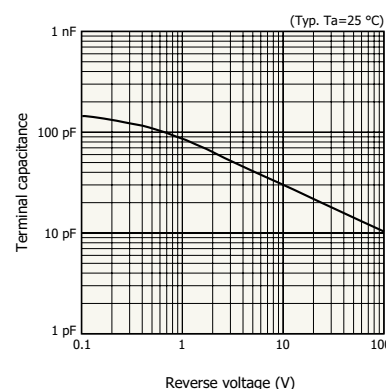







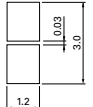

KPINB0389EB

Multi-element type Si photodiodes

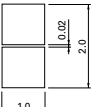
Segmented type Si PIN photodiodes

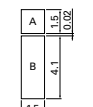
These Si PIN photodiode arrays consist of 2 or 4 elements having sensitivity in the UV to near IR range.

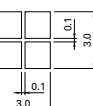
(Typ. Ta=25 °C)

Type no.	Number of elements	Photosensitive area size (mm)	Photosensitivity (A/W)	Cutoff frequency VR=10 V RL=50 Ω (MHz)	Dark current VR=10 V max. (nA)	Terminal capacitance VR=10 V f=1 MHz (pF)	Package	Photo
S3096-02	2	1.2 × 3 /2-seg- ment 	0.39 (λ=650 nm)	25	0.5*1	5	Plastic	
S4204		1 × 2 /2-seg- ment 	0.45 (λ=650 nm)	30	1*1	3		
S9345		1.5 × 1.5 + 1.5 × 4.1 	0.45 (λ=650 nm)	15	5*1	4 (Photo- diode A) 10 (Photo- diode B)		
S4349*2	4	3 × 3 /4-seg- ment 	0.45 (λ=720 nm)	20 (VR=5 V)	0.2 (VR=5 V)	25 (VR=5 V)	TO-5	

*1: Total number of elements

*2: Refer to "Precautions against UV light exposure" (P.48).

Spectral response

[S3096-02, S4204]

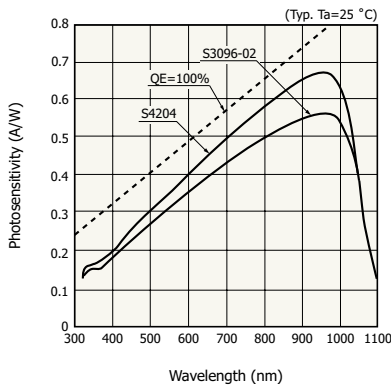

KMPDB0134EE

[S9345]

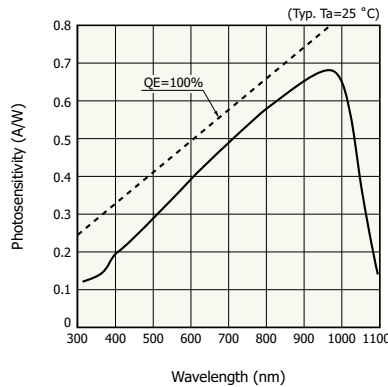

KPINB0336ED

[S4349]

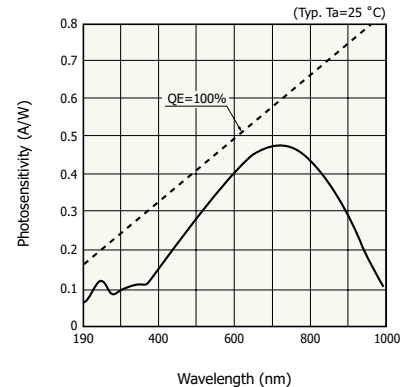

KMPDB0126EB

Dark current vs. reverse voltage

[S3096-02, S4204]

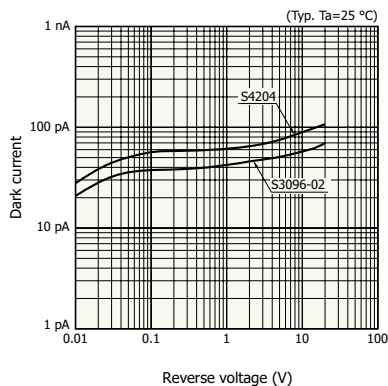

KMPDB0136ED

[S9345]

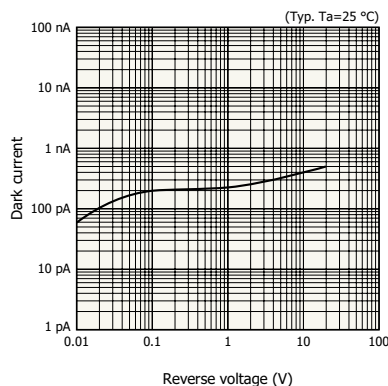

KPINB0295EA



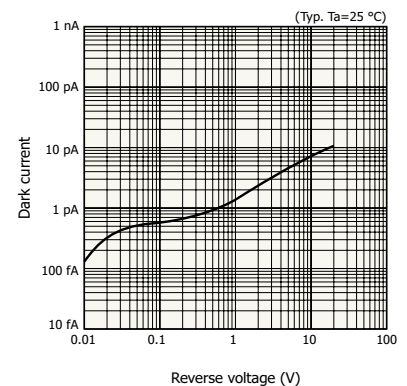



[S4349]

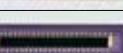

KMPDB0128EA

One-dimensional photodiode arrays (UV to near IR: UV sensitivity enhanced type)

These are Si photodiode linear arrays having rectangular elements equally spaced at a pitch of about 1 mm. (Typ. Ta=25 °C)

Type no.	Number of elements	Photosensitive area size /element (mm)	Element pitch (mm)	Spectral response range (nm)	Photosensitivity $\lambda=960$ nm (A/W)	Dark current $V_R=10$ mV max. (pA)	Terminal capacitance $V_R=0$ V $f=10$ kHz (pF)	Package	Photo			
S4111-16Q*2 S4111-16R	16	1.45 × 0.9	1.0	190 to 1100 340 to 1100	0.58	5	200	Ceramic				
S4111-35Q*2	35	4.4 × 0.9		190 to 1100					10	550	Glass epoxy (unsealed)	
S4111-46Q*2	46			190 to 1100								60
S4114-35Q*2	35			190 to 1000	0.50 ($\lambda=800$ nm)	75						
S4114-46Q*2	46			190 to 1000								
S12858-021 S12859-021	16	0.77 × 2.5		1.17	340 to 1100	0.61 ($\lambda=920$ nm)	30		30	Glass epoxy (unsealed)		
S11299-021 S11212-021		1.175 × 2.0	1.575	30				40				
S12362-021 S12363-021		2.2 × 2.7	2.5								50	75
												

*2: Refer to "Precautions against UV light exposure" (P48).

Spectral response

[S4111/S4114 series]

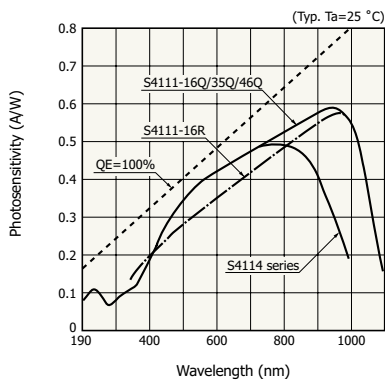

KMPDB0112EC

[S12858/S12859/S12362/S12363/S11212/S11299-021]

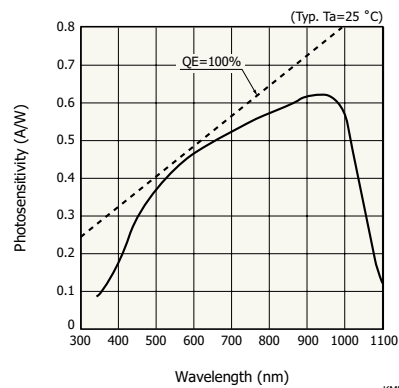

KMPDB0357EA

Structure of photosensitive area (unit: mm)

[S4111/S4114 series]

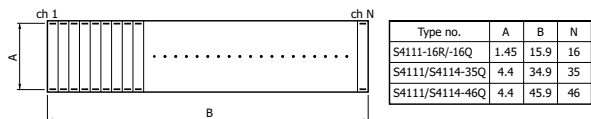

KMPDA0227EC

[S11212/S11299-021]

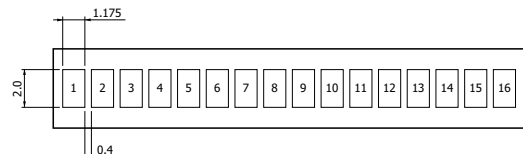





KMPDA0228EC

Surface mount type Si photodiodes







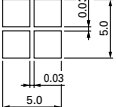

High-speed response Si PIN photodiodes

These are photodiodes sealed in a chip carrier package suitable for surface mounting and allowed solder reflow mounting on PC boards for automated processes. (Typ. Ta=25 °C)

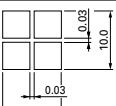
Type no.	Cutoff frequency VR=10 V (MHz)	Photosensitive area size (mm)	Spectral response range (nm)	Photosensitivity λ=960 nm (A/W)	Terminal capacitance VR=10 V f=1 MHz (pF)	Package	Photo
S5106	20	5 × 5	320 to 1100	0.72	40	Ceramic	
S5107	10	10 × 10			150		
S7509	20	2 × 10			40		
S7510	15	6 × 11			80		

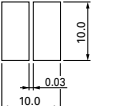
Segmented type Si photodiodes

These Si photodiodes consist of 2, 4 or 16 elements and are integrated into a chip carrier package. (Typ. Ta=25 °C)

Type no.	Number of elements	Photosensitive area size (mm)	Spectral response range (nm)	Photosensitivity λ=960 nm (A/W)	Cutoff frequency VR=10 V (MHz)	Terminal capacitance VR=10 V f=1 MHz (pF)	Package	Photo
S5980	4	5 × 5 /4-seg- ment 	320 to 1100	0.72	25	10	Ceramic	
S5981		10 × 10 /4-seg- ment 			20	35		
S5870	2	10 × 10 /2-seg- ment 			10	50		
S8558	16	2 × 12.7 /16-seg- ment 			25	5		

Spectral response

[S5106, S5107, S7509, S7510, S5980, S5981, S5870]

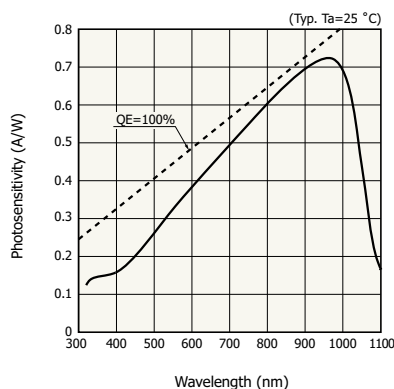

KPINB0165EB

[S8558]

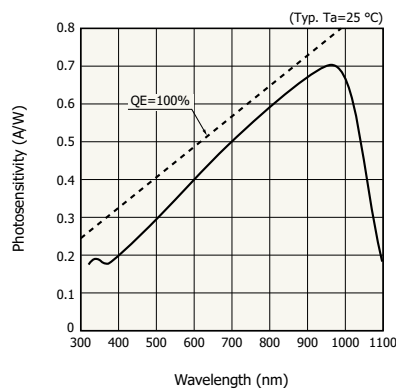

KMPDB0193EB

Terminal capacitance vs. reverse voltage

[S5106, S5107, S7509, S7510]

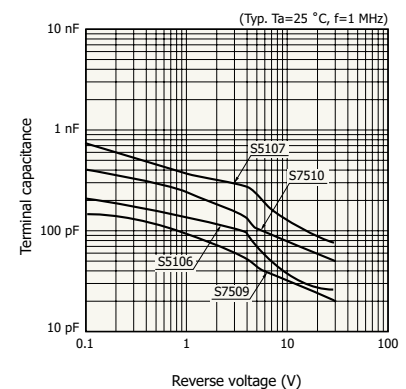



KPINB0128EA

Small package type Si photodiodes

These surface mount type Si photodiodes are mounted on small packages. They are tape packaged and allows solder reflow mounting.





(Typ. Ta=25 °C)

Type no.	Photosensitive area size (nm)	Spectral response range (nm)	Photosensitivity $\lambda=960$ nm (nm)	Terminal capacitance $V_R=0$ V $f=10$ kHz (pF)	Package	Photo
S9674	2 × 2	320 to 1100	0.7	500	Glass epoxy	
S10625-01CT	1.3 × 1.3		0.54 ($\lambda=940$ nm)	200		

Small package type Si PIN photodiodes

These surface mount type Si PIN photodiodes are mounted on small packages. They are tape packaged and allows solder reflow mounting.

(Typ. Ta=25 °C)

Type no.	Photosensitive area size (mm)	Spectral response range (nm)	Photosensitivity $\lambda=960$ nm (A/W)	Terminal capacitance $f=1$ MHz (pF)	Package	Photo
 S13773	$\phi 0.8$	380 to 1000	0.54 ($\lambda=800$ nm)	$\begin{matrix} 3 \\ (V_R=10 \text{ V}) \\ (f=10 \text{ kHz}) \end{matrix}$	Glass epoxy	
S10993-02CT	1.06 × 1.06	380 to 1100	0.6	$\begin{matrix} 6 \\ (V_R=2.5 \text{ V}) \end{matrix}$		
S12158-01CT	2.77 × 2.77	320 to 1100	0.7	$\begin{matrix} 15 \\ (V_R=12 \text{ V}) \end{matrix}$		

Spectral response

[S9674, S10625-01CT]

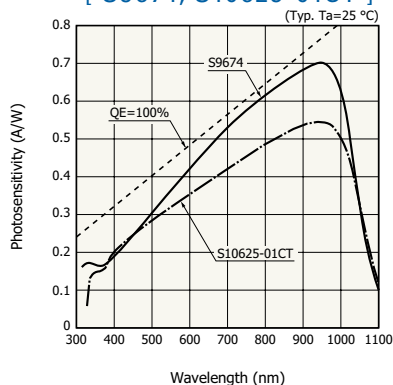

KSPDB0315EB

[S13773, S10993-02CT, S12158-01CT]

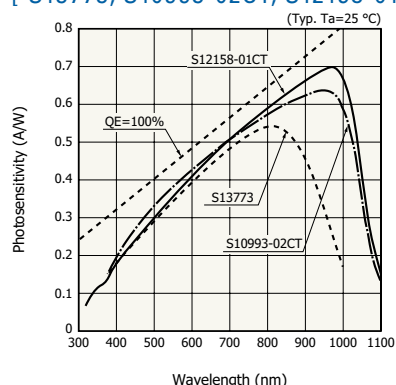

KSPDB0318EC

Dark current vs. reverse voltage

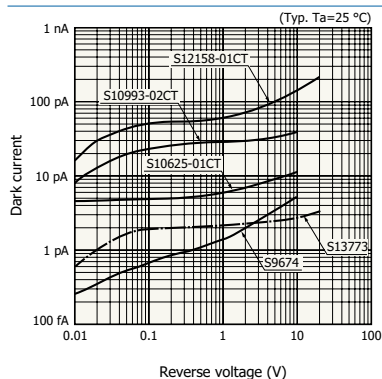







KSPDB0316EE

Si photodiodes with preamp, TE-cooled type Si photodiodes

Si photodiodes with preamp for measurement

These are low noise photosensors incorporating a large area Si photodiode, op amp and feedback capacitance.

(Typ. $T_a=25\text{ }^\circ\text{C}$)

Type no.	Cooling temperature ΔT ($^\circ\text{C}$)	Photosensitive area size (mm)	Spectral response range (nm)	Photosensitivity (V/nW)		NEP $\lambda=\lambda_p, f=10\text{ Hz}$ ($\text{fW}/\text{Hz}^{1/2}$)	Built-in feedback resistance ($\text{G}\Omega$)	Package	Photo
				$\lambda=200\text{ nm}$	$\lambda=960\text{ nm}$				
S8745-01*	Non-cooled	2.4×2.4	190 to 1100	0.12	0.52	11	1	Metal	
S8746-01*		5.8×5.8				15			
S9295*	50	10×10	340 to 1100	0.9	5.1	4	10	Metal	
S9295-01*	30					5			
S9269	Non-cooled	5.8×5.8	340 to 1100	-	0.62	12	1	Ceramic	
S9270		10×10				16			

* Refer to "Precautions against UV light exposure" (P.48).

NEP (noise equivalent power) vs. frequency

[S8745-01]

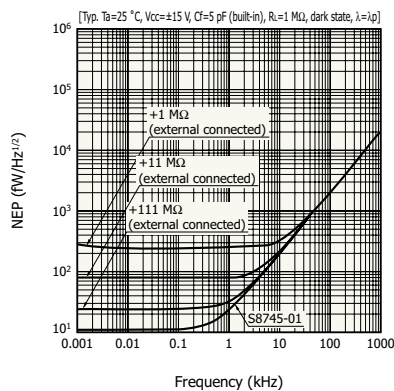

KSPDB0237EA

[S8746-01]

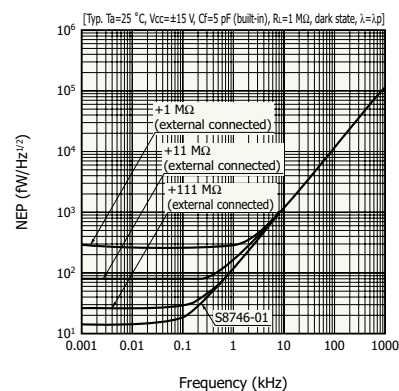

KSPDB0238EA

[S9295 series]

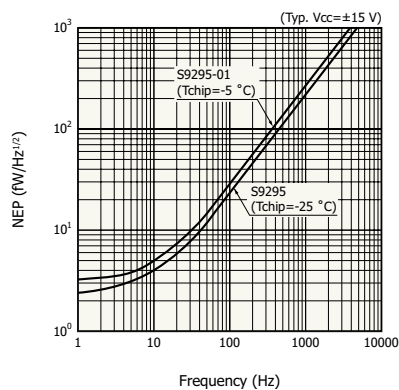

KSPDB0230EC

[S9269, S9270]

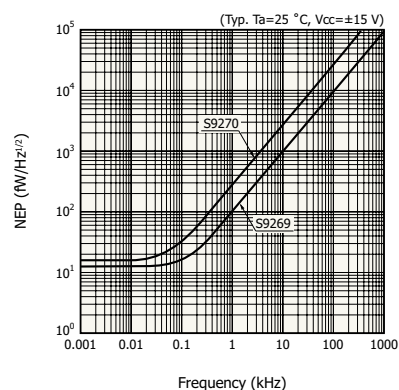



KSPDB0241EA



TE-cooled type Si photodiodes

These photosensors combine a UV to near infrared Si photodiode with a TE-cooler and deliver low dark current.

(Typ. $T_a=25\text{ }^\circ\text{C}$)

Type no.	Cooling temperature ΔT ($^\circ\text{C}$)	Photosensitive area size (mm)	Spectral response range (nm)	Peak sensitivity wavelength (nm)	Dark current $V_R=10\text{ mV}$ (μA)	NEP ($\text{W}/\text{Hz}^{1/2}$)	Package	Photo
S2592-03*	35	2.4×2.4	190 to 1100	960	10	8.1×10^{-15}	TO-8	
S2592-04*		5.8×5.8			25	1.3×10^{-14}		
S3477-03*		2.4×2.4			10	8.1×10^{-15}	TO-66	
S3477-04*		5.8×5.8			25	1.3×10^{-14}		

* Refer to "Precautions against UV light exposure" (P.48).

Spectral response

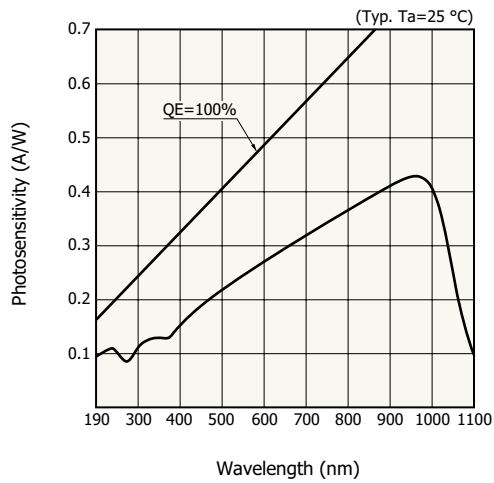

Thermistor temperature characteristics

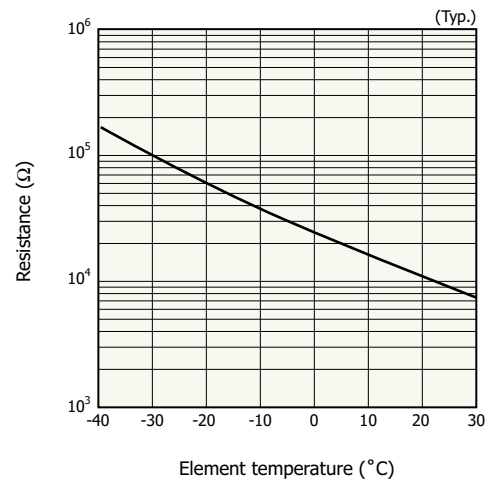



















Si photodiodes for X-ray detection

Si photodiodes with scintillator

These detectors are comprised of a Si photodiode coupled to a scintillator. Ceramic scintillators have sensitivity to X-rays about 1.2 times higher than CWO and offer high reliability. CsI scintillators also have high sensitivity and are low-cost.

The S11212 and S11299 series photodiode arrays have a back-illuminated structure. They realize superb spectral response and sensitivity uniformity compared to our previous products.

(Typ. Ta=25 °C)

Type no.	Scintillator	Photosensitive area size /element (mm)	Number of elements	Dark current max. VR=10 mV (pA)	X-ray sensitivity* (nA)	Package	Photo
S8559	CsI(Tl)	5.8 × 5.8	1	50	52	Ceramic	
S8193	GOS ceramic				30		
S12858-122	Csl(Tl)	0.77 × 2.5	16	30	5.0	Glass epoxy	
S12859-122					2.5		
S12858-324	GOS ceramic	0.77 × 2.5	16	30	2.5		
S12859-324					2.2		
S12858-422	Phosphor sheet	0.77 × 2.5	16	30	2.2		
S12859-422					2.2		
S11299-121	Csl(Tl)	1.175 × 2.0	16	30	6.0		Glass epoxy
S11212-121					3.5		
S11299-321	GOS ceramic	1.175 × 2.0	16	30	3.5		
S11212-321					3.0		
S11299-421	Phosphor sheet	1.175 × 2.0	16	30	3.0		
S11212-421					3.0		
S12362-121	Csl(Tl)	2.2 × 2.7	16	50	12.5	Glass epoxy	
S12363-121					7.2		
S12362-321	GOS ceramic	2.2 × 2.7	16	50	7.2		
S12363-321					6.0		
S12362-421	Phosphor sheet	2.2 × 2.7	16	50	6.0		
S12363-421					6.0		

* These are for reference (X-ray tube voltage: 120 kV, tube current: 1.0 mA, aluminum filter t=6 mm, distance: 830 mm), X-ray sensitivity depends on the X-ray equipment operating and setup conditions.

Spectral response (S12858/S12859/S11212/S11299/S12362/S12363 series)

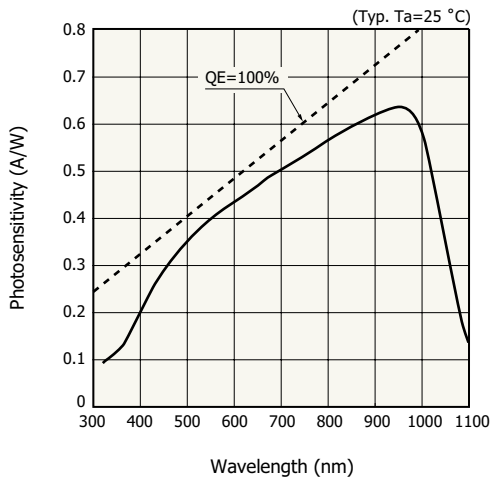

Uniformity (S11212/S11299 series)

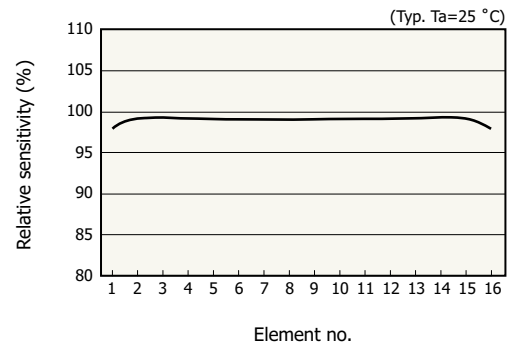

KMPD80361EC

* Spectral response characteristics include the transmittance and reflectance of the adhesive resin used to bond a scintillator.

KMPD80360EC

Emission spectrum of scintillator and spectral response

[S11212/S11299-121 [CsI(Tl)]]

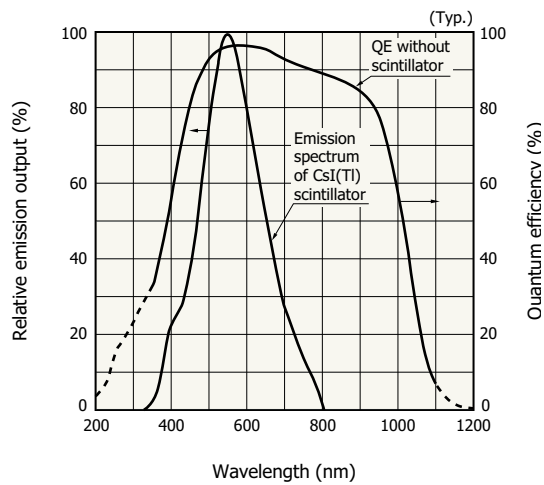

KSPD80282EE

[S11212/S11299-321 (GOS ceramic)]

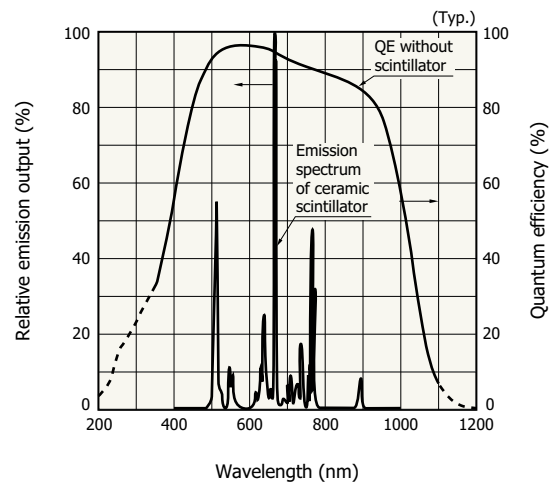

KSPD80281EE

▲ Typical scintillator characteristics

Parameter	Condition	CsI(Tl)	GOS ceramic	Unit
Peak emission wavelength		560	512	nm
X-ray absorption coefficient	100 keV	10	7	cm ⁻¹
Refractive index	$\lambda = \lambda_0 n$	1.7	2.2	-
Decay constant		1	3	μ s
Afterglow	100 ms after X-ray turn off	0.3	0.01	%
Density		4.51	7.34	g/cm ³
Color		Transparent	Light yellow-green	-
Sensitivity nonuniformity		± 10	± 5	%

Large area Si PIN photodiodes

These Si PIN photodiodes, mounted on a white ceramic base, are specifically developed for applications in high energy physics and are mainly used being coupled to a scintillator. Because of high resistance to high voltages, these Si PIN photodiodes operate at high reverse voltages allowing a high-speed response despite the large photosensitive areas.

The S3590-18/-19 are violet sensitivity enhanced type and the S3590-19 is an unsealed type. To improve photodiode-to-scintillator coupling efficiency, we also offer the S8650 with epoxy resin coating window processed to have a flat surface. (Typ. $T_a=25\text{ }^\circ\text{C}$)

Type no.	Window	Photosensitive area size (mm)	Depletion layer thickness $V_R=70\text{ V}$ (mm)	Spectral response range (nm)	Photosensitivity $\lambda=960\text{ nm}$ (A/W)	Dark current max. $V_R=70\text{ V}$ (nA)	Terminal capacitance $V_R=70\text{ V}$ $f=1\text{ MHz}$ (pF)	Package	Photo
S3590-08	Epoxy resin	10 × 10	0.3	340 to 1100	0.66	6	40	Ceramic	
S3590-09	Unsealed								
S3590-18	Epoxy resin				0.65	10			
S3590-19	Unsealed				0.58				
S8650	Epoxy resin				0.66	6			

Spectral response

[S3590-08, S8650]

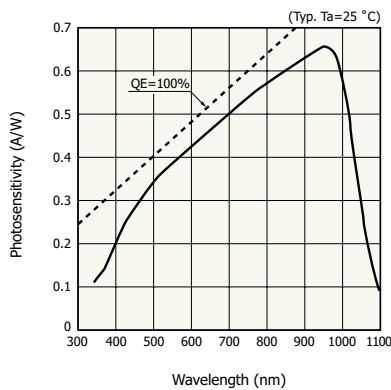

KPINB0347ED

[S3590-09]

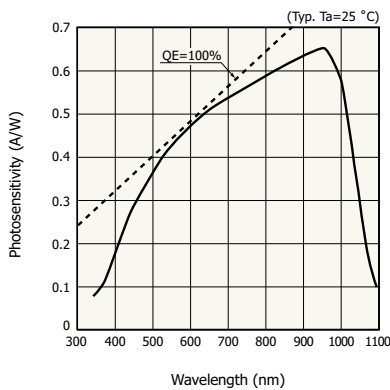

KPINB0263EB

[S3590-18/-19]

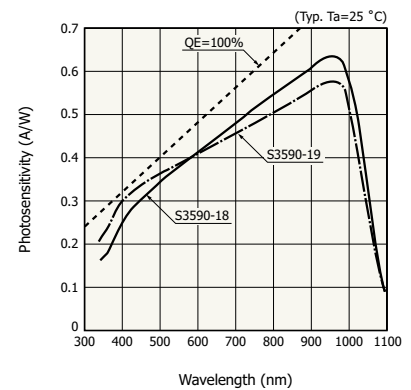

KPINB0322EC

Terminal capacitance vs. reverse voltage

[S3590 series, S8650]

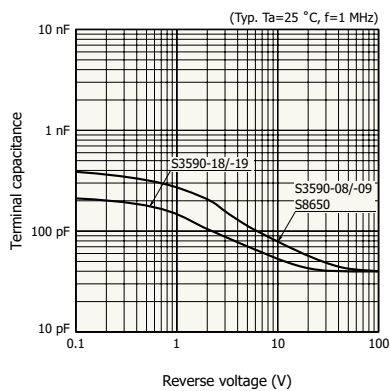



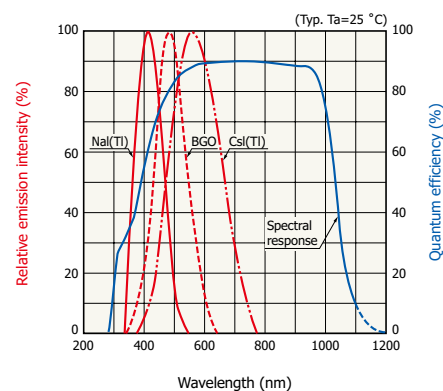

KPINB0331EC

Emission spectrum of scintillators and spectral response (S3590-08)



KPINB0017ED

(Typ. Ta=25 °C)

Type no.	Window	Photosensitive area size (mm)	Depletion layer thickness VR=70 V (mm)	Spectral response range (nm)	Photosensitivity λ=960 nm (A/W)	Dark current max. VR=70 V (nA)	Terminal capacitance VR=70 V f=1 MHz (pF)	Package	Photo				
S2744-08	Epoxy resin	10 × 20	0.3	340 to 1100	0.66	10	85	Ceramic					
S2744-09	Unsealed												
S3204-08	Epoxy resin	18 × 18							20	130	30	300	
S3204-09	Unsealed												
S3584-08	Epoxy resin	28 × 28							10	40	10	40	
S3584-09	Unsealed												
S3588-08	Epoxy resin	3 × 30							10	40	10	40	
S3588-09	Unsealed												

Spectral response

[S2744/S3588 series]

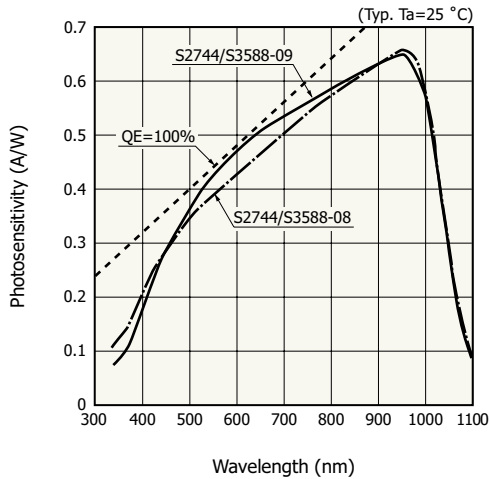

KPINB0265EE

[S3204/S3584 series]

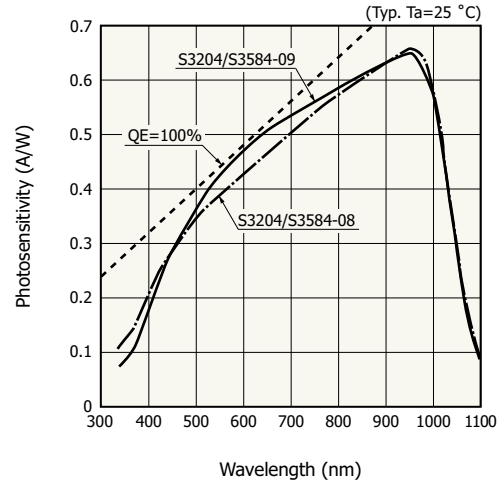

KPINB0277EC

Terminal capacitance vs. reverse voltage

[S2744/S3588 series]

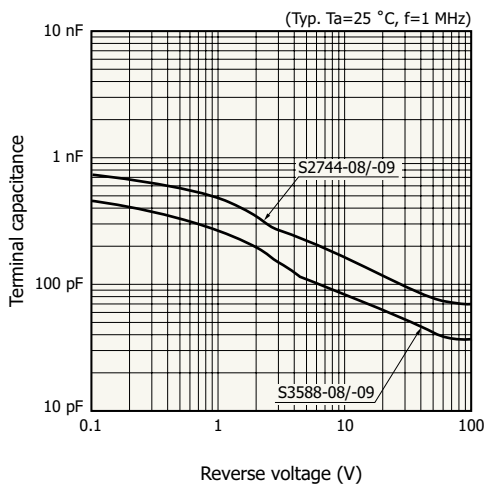

KPINB0222EA

[S3204/S3584 series]

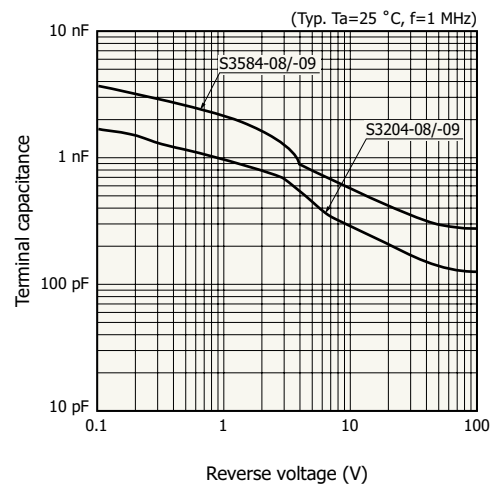





KPINB0230EC

Special application Si photodiodes

RGB color sensors

These photosensors are color sensors using a 3-element photodiode with color sensitivity, assembled in one package.

(Typ. $T_a=25\text{ }^\circ\text{C}$)

Type no.	Spectral response range		Peak sensitivity wavelength (nm)	Photosensitivity $\lambda=\lambda_p$ (A/W)		Dark current $V_R=1\text{ V}$ Total number of elements max. (pA)	Photosensitive area size (mm)		Package	Photo
	Blue	Green		Blue	Green		Blue	Green		
S7505-01	Blue	400 to 540	460	Blue	0.18	200	Blue	$1.5 \times 1.5 (\times 2)$	Surface mount type plastic	
	Green	480 to 600	540	Green	0.23		Green	1.5×1.5		
	Red	590 to 720	620	Red	0.16		Red	1.5×1.5		
S9032-02*1	Blue	400 to 540	460	Blue	0.18	100	$\phi 2 / 3\text{-segment}$		Surface mount type plastic	
	Green	480 to 600	540	Green	0.23					
	Red	590 to 720	620	Red	0.16					
S9702*1	Blue	400 to 540	460	Blue	0.18	50	$1 \times 1 / 3\text{-segment}$		Surface mount type, small plastic	
	Green	480 to 600	540	Green	0.23					
	Red	590 to 720	620	Red	0.16					
S10917-35GT	Blue	390 to 530	460	Blue	0.2	50	$1 \times 1 / 3\text{-segment}$		Surface mount type, small, glass epoxy	
	Green	470 to 600	540	Green	0.23					
	Red	590 to 680	620	Red	0.17					
S10942-01CT	See the spectral response.			Blue	0.21^{*2}	50	$1 \times 1 / 3\text{-segment}$		Surface mount type, small glass epoxy	
				Green	0.25^{*2}					
				Red	0.45^{*2}					

*1: If excessive vibration is continuously applied to the glass filter, there is a risk that the filter may come off, so secure the glass filter with a holder.

*2: Blue: $\lambda=460\text{ nm}$, Green: $\lambda=540\text{ nm}$, Red: $\lambda=640\text{ nm}$

Spectral response

[S7505-01, S9032-02, S9702]

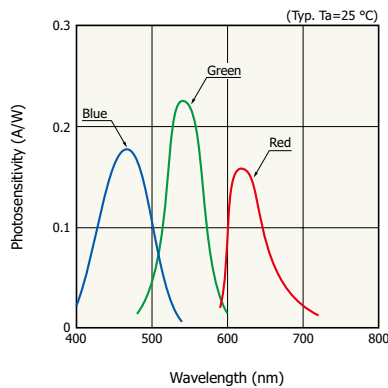

[S10917-35GT]

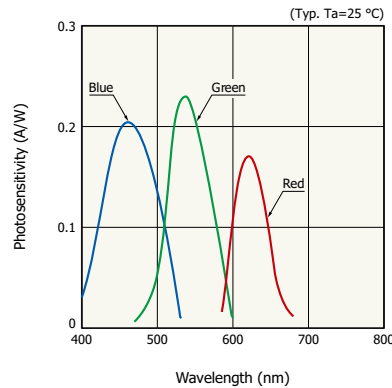

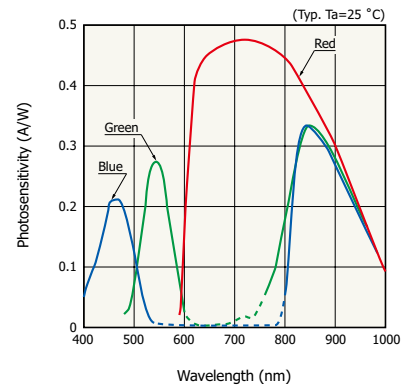

[S10942-01CT]



This sensor also has sensitivity in the infrared region, so cut off infrared light as needed.

The S6428-01, S6429-01 and S6430-01 are monochromatic color sensors sensitive to blue, green and red light, respectively.

(Typ. Ta=25 °C)

Type no.	Spectral response range (nm)	Peak sensitivity wavelength (nm)	Photosensitivity $\lambda=\lambda_p$ (A/W)	Dark current $V_R=1\text{ V}$ max. (pA)	Photosensitive area size (mm)	Package	Photo
S6428-01	400 to 540	460	0.22	20	2.4 × 2.8	Plastic	
S6429-01	480 to 600	540	0.27				
S6430-01	590 to 720	660	0.45				

Spectral response

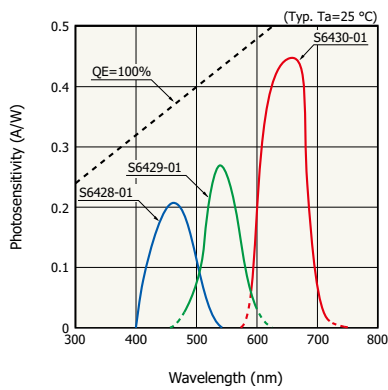



KSPDB0280EC

Violet/blue sensitivity enhanced type

These are photodiodes for violet/blue laser diode detection.

(Typ. $T_a=25\text{ }^\circ\text{C}$)

Type no.	Cutoff frequency (MHz)	Photosensitive area size (MHz)	Peak sensitivity wavelength (MHz)	Photo-sensitivity (MHz)	Dark current max. (MHz)	Terminal capacitance $f=1\text{ MHz}$ (pF)	Package	Photo
S5973-02	1 GHz ($V_R=3.3\text{ V}$)	$\phi 0.4$	760	0.3 ($\lambda=410\text{ nm}$)	0.1 ($V_R=3.3\text{ V}$)	1.6 ($V_R=3.3\text{ V}$)	TO-18	
S9195	50 ($V_R=10\text{ V}$)	5×5	840	0.28 ($\lambda=405\text{ nm}$)	5 ($V_R=10\text{ V}$)	60 ($V_R=10\text{ V}$)	TO-8	
S3994-01	20 ($V_R=30\text{ V}$)	10×10	960	0.25 ($\lambda=400\text{ nm}$)	10 ($V_R=30\text{ V}$)	40 ($V_R=30\text{ V}$)	Ceramic	

Spectral response

[S5973-02]

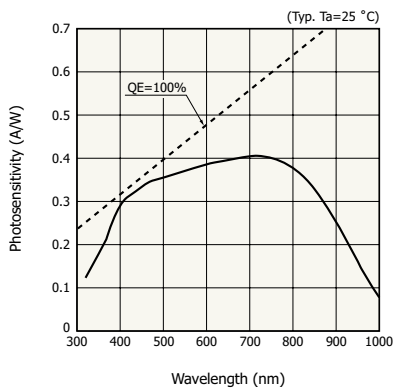

[S9195]

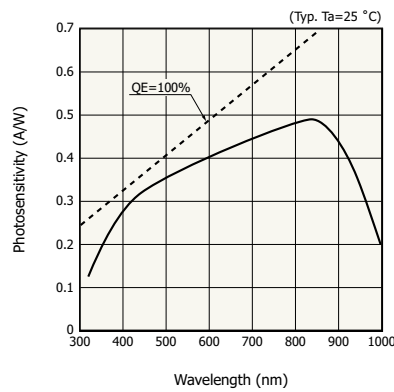

[S3994-01]

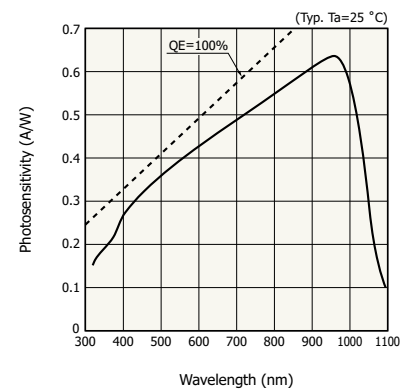

Dark current vs. reverse voltage

[S5973-02]

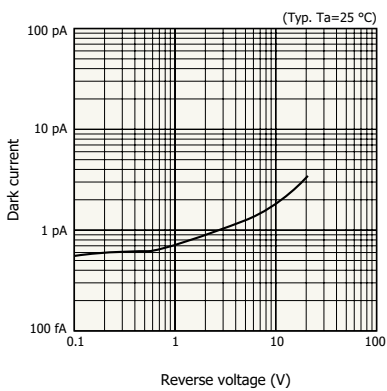

[S9195]

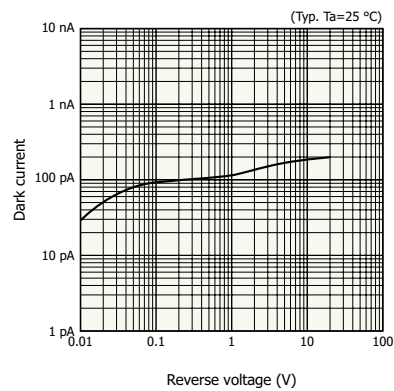

[S3994-01]

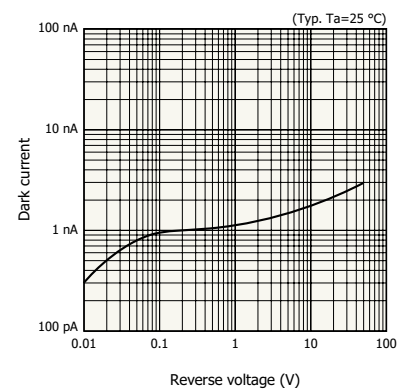

For VUV (vacuum ultraviolet) monitor

These Si photodiodes are specially optimized for excimer laser monitor (ArF: 193 nm, KrF: 248 nm): sensitive in the vacuum UV (VUV) range. (Typ. Ta=25 °C)

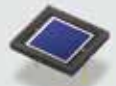
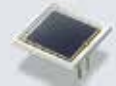
Type no.	Photosensitivity $\lambda=193$ nm (A/W)	Dark current VR=10 mV max. (nA)	Photosensitive area size (mm)	Package	Photo
S8552*	0.06	1.0	10 × 10	Ceramic (unsealed)	
S8553*		5.0	18 × 18		

* Refer to "Precautions against UV light exposure ㉔" (P.48).

For VUV detection (high reliability type)

The S10043 is greatly improved in sensitivity stability even after exposure to ArF ($\lambda=193$ nm) excimer laser.

Type no.	Photosensitivity $\lambda=193$ nm (A/W)	Dark current VR=10 mV max. (nA)	Photosensitive area size (mm)	Package	Photo
S10043*	0.015	1.0	10 × 10	Ceramic (unsealed)	

* Refer to "Precautions against UV light exposure ㉔" (P.48).

Variation in sensitivity due to UV exposure

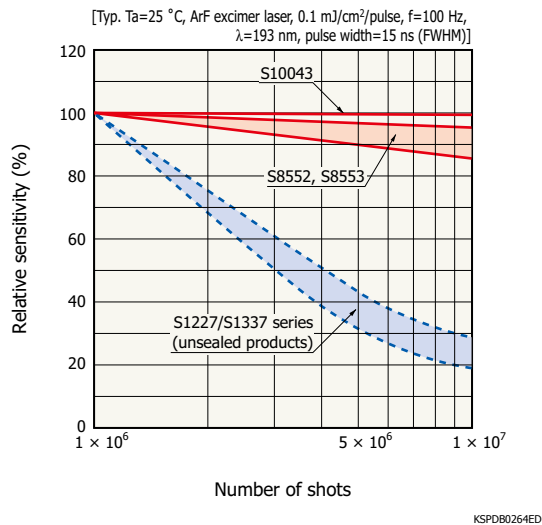

Spectral response

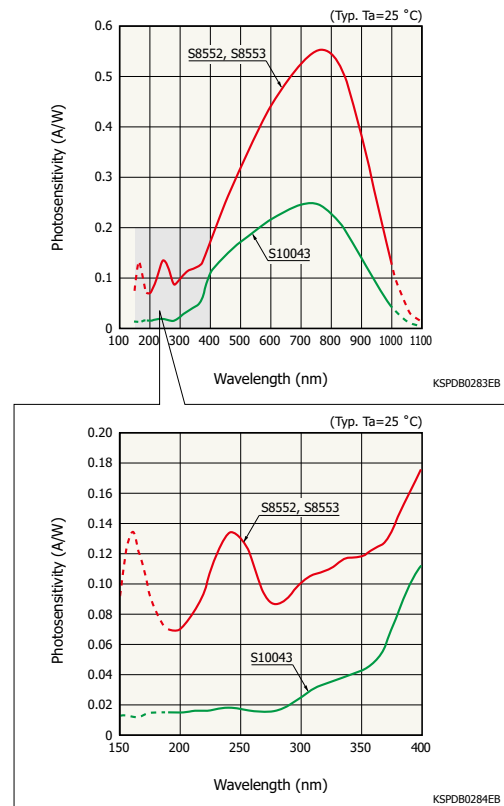

For monochromatic light detection

This photosensor uses an interference filter and has high sensitivity only to monochromatic light.

(Typ. $T_a=25\text{ }^\circ\text{C}$)

Type no.	Peak sensitivity wavelength (nm)	Spectral response half-width (nm)	Photosensitivity $\lambda=254\text{ nm}$ (A/W)	Dark current $V_R=10\text{ mV}$ max. (pA)	Photosensitive area size (mm)	Package	Photo
S12742-254*1	254	10	0.018	25	3.61 × 3.61	TO-5	

*1: Refer to "Precautions against UV light exposure" (P.48).

Spectral response

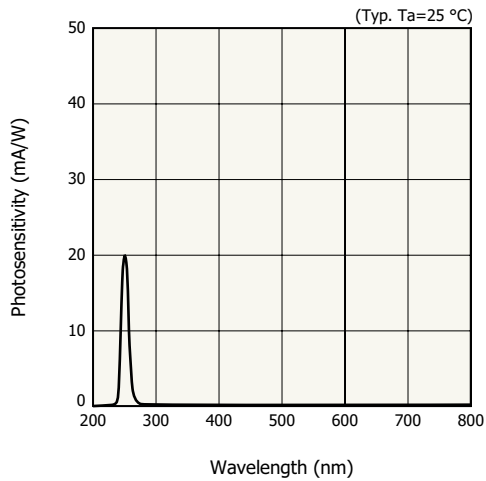

KSPDB0333EA

Note: Different types compatible with wavelengths other than the 254 nm center wavelength are also available (made-to-order product).

For YAG laser detection

This is a Si PIN photodiode developed to measure infrared energy emitted from YAG lasers (1.06 μm).

(Typ. $T_a=25\text{ }^\circ\text{C}$)

Type no.	Photosensitive area size (mm)	Spectral response range (nm)	Peak sensitivity wavelength (nm)	Photosensitivity $\lambda=1060\text{ nm}$ (A/W)	Dark current $V_R=100\text{ V}$ max. (nA)	Rise time $\lambda=1060\text{ nm}$ $V_R=100\text{ V}$, $R_L=50\text{ }\Omega$ (ns)	Package	Photo
S3759	$\phi 5$	360 to 1120	980	0.38	10	12.5	TO-8	

Spectral response

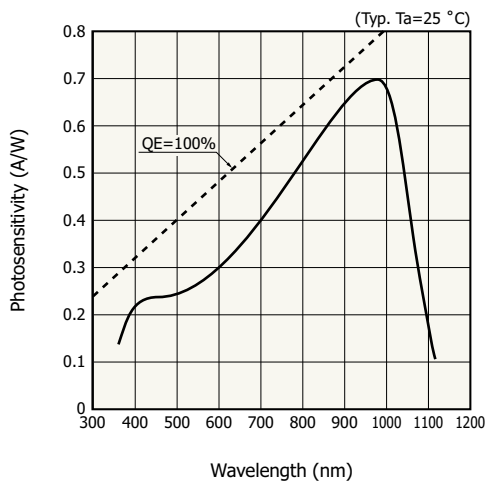

KPINB0279EB

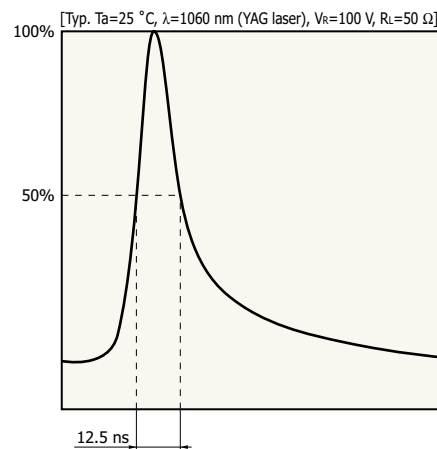

Response waveform



KPINB0280EC

Infrared sensitivity enhanced type

These are Si PIN photodiodes that offer enhanced near-infrared sensitivity due to a MEMS structure formed on the back side of the photodiode. (Typ. Ta=25°C)

Type no.	Photosensitive area size (mm)	Spectral response range (nm)	Photosensitivity $\lambda=1060$ nm (A/W)	Dark current max. (nA)	Terminal capacitance f=1 MHz (pF)	Package	Photo
S11499	$\phi 3$	360 to 1140	0.6	5 (VR=20 V)	13 (VR=20 V)	TO-5	
S11499-01	$\phi 5$		0.6	10 (VR=20 V)	33 (VR=20 V)	TO-8	
S12028	$\phi 1.2$		0.5 (VR=10 V)	2 (VR=10 V)	4 (VR=10 V)	TO-18	

Spectral response

[S11499 series]

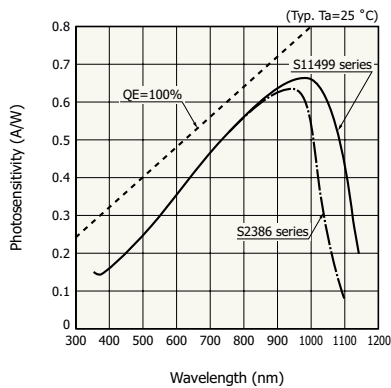

KPINB0368EC

[S12028]

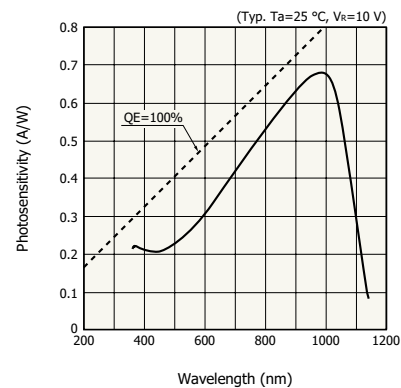

KPINB0376EC

For electron beam detector

These photodiodes directly detect low energy (1 keV or more) electron beams with high sensitivity. The structure with an extremely thin dead layer (insensitive layer) makes these photodiodes ideal for backscattered electron detector for Scanning Electron Microscope (SEM).

(Typ. Ta=25°C)

Type no.	Incident electron energy range (keV)	Output current (nA)	Dark current VR=5 V max. (nA)	Terminal capacitance VR=5 V (pF)	Cutoff frequency VR=5 V (MHz)	Electron multiplying gain	Package	Photo
S11141-10	1 to 30	30 (Electron energy: 1.5 keV Ip*2=100 pA)	60	450	2.5	300 (Electron energy: 1.5 keV)	Thin ceramic (unsealed)	
S11142-10								200

*2: Probe current

Gain vs. electron energy

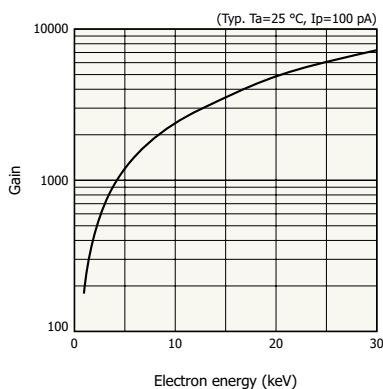

KSPDB0344EA

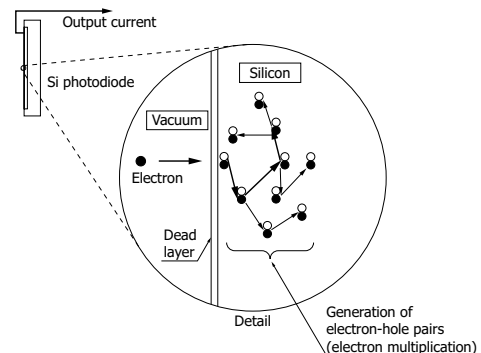

Electron multiplication principle



Electrons generate ions as they pass through silicon. This ionization process generates a large number of electron-hole pairs that then multiply the number of electrons. The electron multiplication can boost the output current by approximately 300 times at an input electron energy of 1.5 keV (refer to "Gain vs. electron energy").

CSP type

The S10356-01 and S10355-01 are back-illuminated type photodiodes designed to minimize the dead areas at the device edges by using a CSP (chip size package) structure. The CSP also allows using multiple devices in a tiled format. (Typ. $T_a=25\text{ }^\circ\text{C}$)

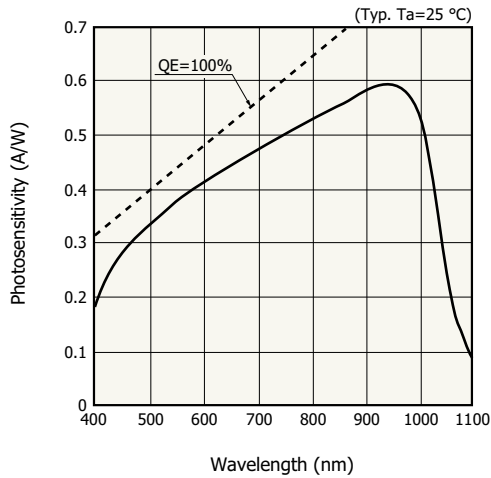

Type no.	Package size (mm)	Spectral response range (nm)	Peak sensitivity wavelength (nm)	Photo-sensitivity $\lambda=960\text{ nm}$ (A/W)	Short circuit current 100 lx, 2856 K (μA)	Terminal capacitance $V_R=0\text{ V}$, $f=10\text{ kHz}$ (pF)	Package	Photo
S10356-01	3 × 3	400 to 1100	960	0.59	5	60	PWB (unsealed)	
S10355-01	7.52 × 7.52				40	500		

Spectral response



PWB package with leads type

The S12497 and S12498 are Si photodiodes suitable for non-destructive inspection of baggage and the like and general industrial measurement. As they are back-illuminated photodiodes, photosensitive area does not have wires, and therefore a scintillator can be mounted directly on the photodiode. (Typ. $T_a=25\text{ }^\circ\text{C}$)

Type no.	Photosensitive area (mm)	Spectral response range (nm)	Peak sensitivity wavelength (nm)	Photo-sensitivity $\lambda=920\text{ nm}$ (A/W)	Short circuit current 100 lx, 2856 K (μA)	Terminal capacitance $V_R=0\text{ V}$, $f=10\text{ kHz}$ (pF)	Photo
S12497	9.5 × 9.5	400 to 1100	920	0.57	75	950	
S12498	6 × 6				30	380	

Spectral response

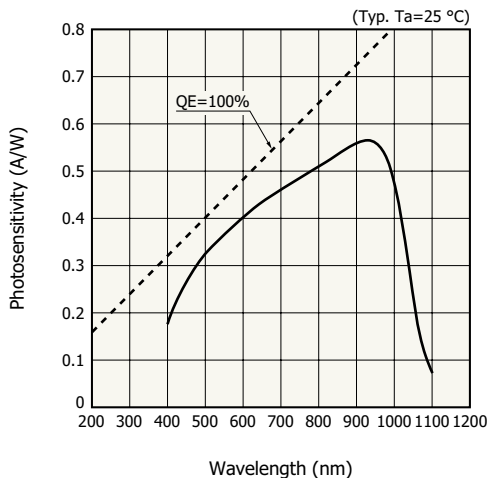

Related products of Si photodiode

RGB color sensor modules

For TFT-LCD monitor

● RGB-LED backlight monitor for TFT-LCD (liquid crystal display)

Features

- Built-in RGB color sensor (S9032-02)
Sensitivity matches wavelengths of RGB-LED backlight for TFT-LCD.
- 3 ch current-to-voltage amplifiers
Simultaneous output of 3 ch RGB photocurrent
- Configuration and size suitable for side mounting to TFT-LCD
- Low current consumption: 0.4 mA typ.
(1/3 than the conventional type)
- High gain type (C9303-04)

Applications

- RGB-LED backlight monitor for TFT-LCD



(Typ. Ta=25 °C)

Type no.	Photosensitivity (V/mW)			Cutoff frequency -3 dB (kHz)	Supply voltage (V)
	$\lambda_p=620$ nm	$\lambda_p=540$ nm	$\lambda_p=460$ nm		
C9303-03	-14	-20	-18	16	+2.7 to +5.5
C9303-04	-108	-156	-122	2.4	

Color sensor evaluation circuit

● Color sensor evaluation circuit board

Features

- 3 ch current-to-voltage conversion amplifier for color sensor evaluation
- Color sensors that mount on C9331:
S7505-01, S9032-02 (sold separately)

Applications

- Evaluation of Hamamatsu color sensor



(Ta=25 °C, Vcc=9.0 V, common to each RGB channel)

Type no.	Output offset voltage $Z_t=5.1 \times 10^5$ V/A [without photodiode] (mV)		Conversion impedance (V/A)	Cutoff frequency [without photodiode] -3 dB (kHz)	Supply voltage (V)
	Typ.	Max.			
C9331	±40	±50	1×10^5 to 5.1×10^5	14	+7 to +15

Driver circuit for Si photodiode array

● Driver circuit for 16-element photodiode array

Features

- High precision and high-speed measurement by simultaneous 16-channel readout
- Assembled with pulse generator (8-step adjustable oscillatory frequency)
CLK, START, A/D conversion Trig and EOS pulse output
- Choice of gain (conversion impedance): 1×10^6 V/A or 1×10^7 V/A
- Single power supply operation: +12 V



Type no.	Applicable sensor
C9004	Hamamatsu S4111-16 series, S11212 series photodiode arrays are directly mountable on board.

Photodiode modules

● Integrates a Si photodiode for precision photometry with low-noise amplifier.

The C10439 series is a high-precision photodetector that combines a photodiode and current-to-voltage conversion amplifier.

Features

- Easy handling
- Two switchable photosensitivity ranges
- Compact size



(Typ. Ta=25 °C)

Type no.	Photosensitive area size (mm)	Photosensitivity $\lambda=\lambda_p$		Conversion impedance		Cutoff frequency -3 dB		Supply voltage (V)	Dimensions W × D × H (mm)
		High range (mV/nW)	Low range (mV/nW)	High range (V/A)	Low range (V/A)	High range (Hz)	Low range (Hz)		
C10439-01	2.4 × 2.4	500	5	10^9	10^7	10	1 k	External power supply ±5 to ±12	19 × 46 × 52
C10439-02	5.8 × 5.8								
C10439-03	10 × 10								
C10439-07	2.4 × 2.4	0.5	0.005	10^6	10^4	1 k	100 k*1		
C10439-08	5.8 × 5.8								
C10439-09	10 × 10								
C10439-10	φ1	1	0.01	10^7	10^6	100	1 k		19 × 50 × 52
C10439-11	φ3								
C10439-14	0.7 × 0.7	0.045*2	0.0045*2	10^7	10^6	100	1 k		

*1: Output amplitude 2 Vp-p *2: Uniform irradiation on the entire photosensitive area

Signal processing unit for photodiode module

● Unit dedicated for photodiode module (C10439 series)

The C10475 converts the output from a photodiode module (C10439 series) into digital signals. Also supplies power to the photodiode module.

Features

- High-resolution digital output (16-bit)
- Data logger function



RS-232C cable is optional.

(Typ. Ta=25 °C)

Type no.	Digital output	Minimum measurement time interval (ms)	Supply voltage (V)	Dimensions W × D × H (mm)
C10475	Conforms to RS-232C (16-bit)	50	AC adapter (+12) or battery (+9)	110 × 100 × 30

Photosensor amplifier

For low-light-level detection

- Digital output function, current-to-voltage conversion amplifier for amplifying very slight photocurrent with low noise

Features

- Three sensitivity ranges
- Selectable operation modes (analog output / digital output)
- Serial connection (RS-232C) with PC
- Data logger function, low battery function



Photodiode, coaxial cable with BNC-BNC plug and RS-232C cable are optional.

(Typ. Ta=25 °C)

Type no.	Range	Conversion impedance (V/A)	Cutoff frequency -3 dB (Hz)	Power supply (V)	Dimensions W × D × H (mm)
C9329	H	10 ⁹	16	AC adapter (+12) or battery (+9)	115 × 90 × 40
	M	10 ⁷	1600		
	L	10 ⁵	1600		

With optical fiber

- Light-to-voltage conversion amplifier with optical fiber

Features

- Easy handling
Built-in photodiode allows easy detection of light just by connecting to a voltmeter, etc.
- Optical fiber light input
Measures light at a narrow detection point. Separating the amplifier from the detection point allows measurement in unusual environments and achieves low noise.
- Three sensitivity ranges



(Typ. Ta=25 °C)

Type no.	Range	Photosensitivity λ=830 nm (mV/μW)	Conversion impedance (V/A)	Cutoff frequency -3 dB (MHz)	Power supply (V)	Dimensions W × D × H (mm)
C6386-01	H	30	10 ⁵	1	External power supply (±15) or batteries (two 9 V batteries)	115 × 90 × 40
	M	3	10 ⁴	3		
	L	0.3	10 ³	10		

High-speed type

- Current-to-voltage conversion amplifier

Features

- C8366: for high speed Si PIN photodiode
C8366-01: for high speed InGaAs photodiode
- Wide bandwidth: DC to 100 MHz typ. (-3 dB; varied by the photodiode used)
- Just inserting the photodiode leads makes the connection.
(Compatible with TO-8, TO-5 and TO-18 packages)
- Adjustable response speed
Response speed can be adjusted by a trimmer potentiometer easily.
- Compact size



(Typ. Ta=25 °C)

Type no.	Conversion impedance (V/A)	Cutoff frequency -3 dB (MHz)	Power supply (V)	Dimensions W × D × H (mm)
C8366	10 ³	100	External power supply (±15)	19 × 52 × 46
C8366-01				

Compact board type

● Current-to-voltage conversion amplifier for low-level-light



(Typ. Ta=25 °C)

Type no.	Conversion impedance (V/A)	Cutoff frequency -3 dB (Hz)	Power supply (V)	Dimensions W × D × H (mm)
C9051	10^8	16	AC adapter (+12)	50 × 50 × 19

Charge amplifier

● For radiation and high energy particle detection

The H4083 is a low-noise hybrid charge amplifier designed for a wide range of spectrometric applications including soft X-ray and low to high energy gamma-ray spectrometry. The first stage of this amplifier uses a low-noise junction type FET, which exhibits excellent performance when used with a photodiode having a large junction capacitance. The H4083 is especially suited for use with Hamamatsu S3590/S3204 series, etc. Si PIN photodiodes. S3590 series photodiodes can be directly mounted on the backside of the H4083, so there will be no increase in stray capacitance.



Features

- Low noise
- Compact and lightweight
- Easy handling

Applications

- Detection of X-rays, radiation, high energy particles

(Typ. Ta=25 °C)

Type no.	Amplification method	Input/output polarity	Charge gain	Noise characteristic (e-/FWHM)	Negative feedback constant	Power supply (V)	Current consumption (mW)	Dimensions W × D × H (mm)
H4083	Charge-sensitive type	Inverted	0.5 V/pC 22 mV/MeV (Si)	550	$50 \text{ M}\Omega//2 \text{ pF}$	± 12	150	24 × 19 × 4

Description of terms

▶ Spectral response

The photocurrent produced by a given level of incident light varies with the wavelength. This relation between the photoelectric sensitivity and wavelength is referred to as the spectral response characteristic and is expressed in terms of photosensitivity or quantum efficiency.

▶ Photosensitivity: S

This measure of sensitivity is the ratio of photocurrent expressed in amperes (A)—or output voltage expressed in volts (V)—to the incident light expressed in watts (W). It may be represented as either an absolute sensitivity (A/W or VW unit) or as a relative sensitivity normalized for the sensitivity at the peak wavelength, usually expressed in percent (%) with respect to the peak value. At Hamamatsu, we usually use absolute sensitivity to express photosensitivity, and the spectral response range is defined as the region in which the relative sensitivity is higher than 5% or 10% of the peak value.

▶ Quantum efficiency: QE

The quantum efficiency is the number of electrons or holes that can be detected as a photocurrent, divided by the number of incident photons. This is commonly expressed in percent (%). The quantum efficiency and photo sensitivity S have the following relationship at a given wavelength (nm):

$$QE = \frac{S \times 1240}{\lambda} \times 100 [\%]$$

▶ Short circuit current: I_{sc}

The output current that flows through the photodiode when the load resistance is 0. This is often called "white light sensitivity" with regards to the spectral response, and a tungsten lamp of 2856 K distribution temperature (color temperature) is used for the light source. At Hamamatsu, we indicate the short circuit current at 100 lx illuminance in the table of characteristics in our catalogues.

▶ Open circuit voltage: Voc

The open circuit voltage is a photovoltaic voltage generated when the load resistance is infinite. The open circuit voltage depends on the light level, but for light levels higher than extremely low levels, it is nearly constant.

▶ Dark current: I_D

The dark current is a small current which flows when a reverse voltage is applied to a photodiode even in dark state. This is a major source of noise for cases in which a reverse voltage is applied to photodiodes (PIN photodiode, etc.).

▶ Shunt resistance: R_{sh}

The voltage-to-current ratio in the vicinity of 0 V in photodiodes. The shunt resistance is defined as follows: Where I_D is the dark current at V_R=10 mV.

$$R_{sh} [\Omega] = \frac{0.01 [V]}{I_D [A]}$$

For applications where no reverse voltage is applied, noise resulting from the shunt resistance becomes predominant.

▶ Terminal capacitance: C_t

An effective capacitor is formed at the PN junction of a photodiode. Its capacitance is termed the junction capacitance and is one of parameters that determine the response speed of the photodiode. And it probably causes a phenomenon of gain peaking in I/V converter using operational amplifier. In Hamamatsu, the terminal capacitance including this junction capacitance plus package stray capacitance is listed.

▶ Rise time: t_r

This is the measure of the time response of a photodiode to a stepped light input, and is defined as the time required for the output to change from 10% to 90% of the maximum light level (steady output level).

▶ Cutoff frequency: f_c

The frequency at which the photodiode output decreases by 3 dB from the output in the frequency region where the output is constant. The rise time (t_r) has a relation with the cut-off frequency (f_c) as follows:

$$t_r [s] = \frac{0.35}{f_c [Hz]}$$

▶ NEP (noise equivalent power)

The NEP is the amount of light equivalent to the noise level of a device. It is the light level required to obtain a signal-to-noise ratio of unity. Our data sheets show the NEP values measured at the peak wavelength λ_p. Since the noise level is proportional to the square root of the frequency bandwidth, the NEP is measured at a bandwidth of 1 Hz.

$$NEP [W/Hz^{1/2}] = \frac{\text{Noise current [A/Hz}^{1/2}]}{\text{Photosensitivity [A/W] at } \lambda_p}$$

▶ Maximum reverse voltage: V_{R max}

Applying a reverse voltage to a photodiode triggers a breakdown at a certain voltage and causes severe deterioration of the device performance. Therefore the absolute maximum rating is specified for reverse voltage at the voltage somewhat lower than this breakdown voltage. The reverse voltage shall not exceed the maximum rating, even instantaneously.

Reference (Physical constants related to light and opto-semiconductors)

Constant	Symbol	Value	Unit
Electron charge	q	1.602 × 10 ⁻¹⁹	C
Speed of light in vacuum	c	2.998 × 10 ⁸	m/s
Planck's constant	h	6.626 × 10 ⁻³⁴	J · s
Boltzmann's constant	k	1.381 × 10 ⁻²³	J/K
Thermal energy at room temperature	kT	0.0259 (300 K)	eV
Energy of 1 eV	eV	1.602 × 10 ⁻¹⁹	J
Wavelength equivalent to 1 eV in vacuum	—	1240	nm
Permittivity of vacuum	ε ₀	8.854 × 10 ⁻¹²	F/m
Relative permittivity of silicon	ε _{si}	Approx. 12	—
Relative permittivity of silicon oxide film	ε _{ox}	Approx. 4	—
Band gap energy of silicon	E _g	Approx. 1.12 (25 °C)	eV

Principle of operation, equivalent circuit

» Principle of operation

Figure 1 shows a cross section of a photodiode. The P-layer material at the active surface and the N material at the substrate form a PN junction which operates as a photoelectric converter. The usual P-layer for a Si photodiode is formed by selective diffusion of boron, to a thickness of approximately 1 μm or less and the neutral region at the junction between the P- and N-layers is known as the depletion layer. By controlling the thickness of the outer P-layer, N-layer and bottom N⁺-layer as well as the doping concentration, the spectral response and frequency response can be controlled.

If the light energy is greater than the band gap energy (E_g), the electrons are pulled up into the conduction band, leaving holes in their place in the valence band (see Figure 2). These electron-hole pairs occur throughout the P-layer, depletion layer and N-layer materials. In the depletion layer the electric field accelerates these electrons toward the N-layer and the holes toward the P-layer. Of the electron-hole pairs generated in the N-layer, the electrons, along with electrons that have arrived from the P-layer, are left in the N-layer conduction band. The holes at this time are being diffused through the N-layer up to the depletion layer while being accelerated, and collected in the P-layer valence band. In this manner, electron-hole pairs which are generated in proportion to the amount of incident light are collected in the N- and P-layers. This results in a positive charge in the P-layer and a negative charge in the N-layer. When an electrode is formed from each of the P-layer and N-layer, and connected to external circuit, electrons will flow away from the N-layer, and holes will flow away from the P-layer toward the opposite respective electrodes. These electrons and holes generating a current flow in a semiconductor are called the carriers.

[Figure 1] Si photodiode cross section

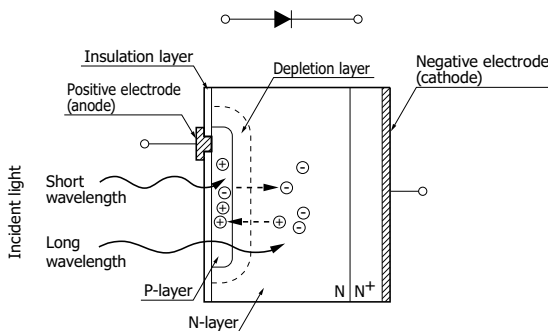

KPDC0002EA

[Figure 2] Si photodiode P-N junction state

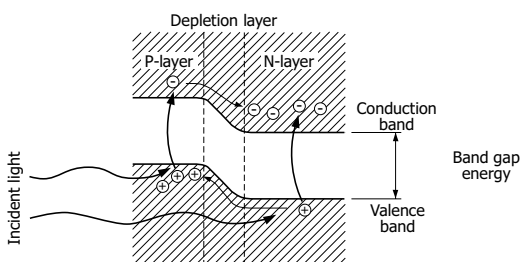

KPDC0003EA

» Equivalent circuit

An equivalent circuit of a photodiode is shown in Figure 3.

[Figure 3] Photodiode equivalent circuit

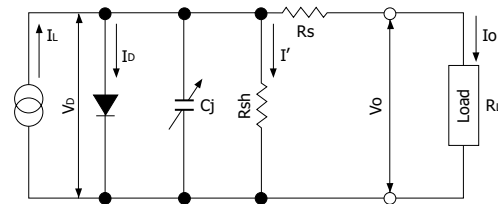

KPDC0004EA

- I_L : Current generated by the incident light (proportional to the amount of light)
- V_D : Voltage across the diode
- I_D : Diode current
- C_j : Junction capacitance
- R_{sh} : Shunt resistance
- I' : Shunt resistance current
- R_s : Series resistance
- V_o : Output voltage
- I_o : Output current

Using the above equivalent circuit, the output current I_o is given as follows:

$$I_o = I_L - I_D - I' = I_L - I_s \left(\exp \frac{q V_D}{k T} - 1 \right) - I' \dots \dots \dots (1)$$

- I_s : Photodiode reverse saturation current
- q : Electron charge
- k : Boltzmann's constant
- T : Absolute temperature of the photodiode

The open circuit voltage V_{oc} is the output voltage when I_o equals zero and expressed by equation (2).

$$V_{oc} = \frac{k T}{q} \ln \left(\frac{I_L - I'}{I_s} + 1 \right) \dots \dots \dots (2)$$

If I' is negligible, since I_s increases exponentially with respect to ambient temperature, V_{oc} is inversely proportional to the ambient temperature and proportional to the log of I_L. However, this relationship does not hold for very low light levels.

The short circuit current I_{sc} is the output current when the load resistance (R_L) = 0 and V_o = 0, and is expressed by equation (3).

$$I_{sc} = I_L - I_s \left(\exp \frac{q \times I_{sc} \times R_s}{k T} - 1 \right) - \frac{I_{sc} \times R_s}{R_{sh}} \dots \dots \dots (3)$$

In the above relationship, the 2nd and 3rd terms limit the linearity of I_{sc}. However, since R_s is several ohms and R_{sh} is 10⁷ to 10¹¹ ohms, these terms become negligible over quite a wide range.

Application circuit examples

» Low-light-level detection circuit

Low-light-level detection circuits require measures for reducing electromagnetic noise in the surrounding area, AC noise from the power supply, and internal op amp noise, etc.

Figure 4 shows one measure for reducing electromagnetic noise in the surrounding area.

[Figure 4] Low-light-level sensor head

(a) Example using shielded cable to connect to photodiode

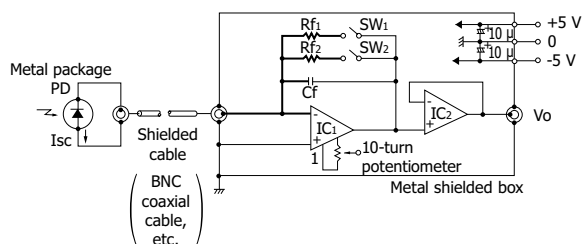

KSPDC0051EC

(b) Example using metal shielded box that contains entire circuit

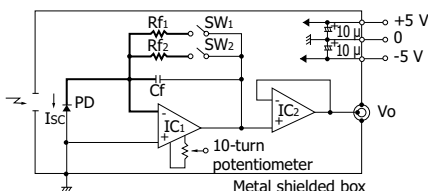

KSPDC0052EB

(c) Example using optical fiber

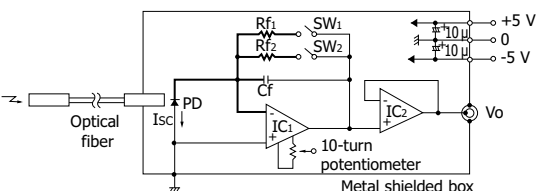

Bold lines should be within guarded pattern or on teflon terminals.

IC1: FET-input op amp, etc.

IC2: OP07, etc.

Cf: 10 pF to 100 pF, polystyrene capacitor

Rf: 10 GΩ max.

SW: Low-leakage reed relay or switch

PD: S1226/S1336/S2386 series, S2281, etc.

$$V_o = I_{sc} \times R_f [V]$$

KSPDC0053EB

Extracting the photodiode signal from the cathode terminal is another effective means. An effective countermeasure against AC noise from the power supply is inserting an RC filter or an LC filter in the power supply line. Using a dry cell battery as the power supply also proves effective way. Op amp noise can be reduced by selecting an op amp having a low 1/f noise and low equivalent input noise current. Moreover, high-frequency noise can be reduced by using a feedback capacitor (Cf) to limit the circuit frequency range to match the signal frequency bandwidth. Output errors (due to the op amp input bias current and input offset voltage, routing of the circuit wiring, circuit board surface leak current, etc.) should be reduced, next. A FET input op amp with input bias currents below a few hundred fA or CMOS

input op amp with low 1/f noise are selected. Using an op amp with input offset voltages below several millivolts and an offset adjustment terminal will prove effective. Also try using a circuit board made from material having high insulation resistance. As countermeasures against current leakage from the surface of the circuit board, try using a guard pattern or elevated wiring with teflon terminals for the wiring from the photodiode to op amp input terminals and also for the feedback resistor (Rf) and feedback capacitor (Cf) in the input wiring.

Hamamatsu offers the C6386-01, C9051 and C9329 photosensor amplifiers optimized for use with photodiodes for low-light-level detection.

[Figure 5] Photosensor amplifiers

(a) C6386-01



(b) C9051



(c) C9329



The photodiodes, and coaxial cables with BNC-to-BNC plugs are sold separately.

» Light-to-logarithmic-voltage conversion circuit

The voltage output from a light-to-logarithmic voltage conversion circuit (Figure 6) is proportional to the logarithmic change in the detected light level. The log diode D for logarithmic conversion should have low dark current and low series resistance. A Base-Emitter junction of small signal transistors or Gate-Source junction of connection type of FETs can also be used as the diode. I_B is the current source that supplies bias current to the log diode D and sets the circuit operating point. Unless this I_B current is supplied, the circuit will latch up when the photodiode short circuit current I_{sc} becomes zero.

[Figure 6] Light-to-logarithmic-voltage conversion circuit

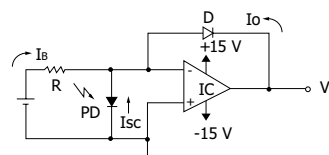

D: Diode of low dark current and low series resistance

I_B : Current source for setting circuit operation point, $I_B \ll I_{sc}$

R: 1 GΩ to 10 GΩ

I_o : D saturation current, 10^{-15} to 10^{-12} A

IC: FET-input op amp, etc.

$$V_o \approx -0.06 \log \left(\frac{I_{sc} + I_B}{I_o} + 1 \right) [V]$$

KPD0021EA

» Light integration circuit

This is a light integration circuit using integration circuits of photodiode and op amp and is used to measure the integrated power or average power of a light pulse train with an erratic pulse height, cycle and width.

The integrator IC in the figure 7 accumulates short circuit current I_{sc} generated by each light pulse in the integration capacitance C . By measuring the output voltage V_o immediately before reset, the average short circuit current can be obtained from the integration time (t_o) and the capacitance C . A low dielectric absorption type capacitor should be used as the capacitance C to eliminate reset errors. The switch SW is a CMOS analog switch.

[Figure 7] Light integration circuit

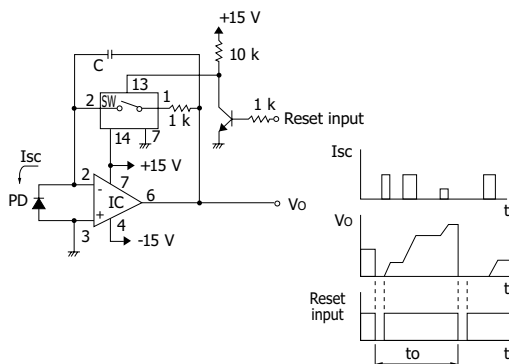

Reset input: Use TTL "L" to reset.
 IC : LF356, etc.
 SW: CMOS 4066
 PD : S1226/S1336/S2386 series, etc.
 C : Polypropylene film capacitor, etc.

$$V_o = I_{sc} \times t_o \times \frac{1}{C} [V]$$

KPDC0027EC

» Basic illuminometer (1)

A basic illuminometer circuit can be configured by using Hamamatsu C9329 photosensor amplifier and S9219 Si photodiode with sensitivity corrected to match human eye response. As shown in Figure 8, this circuit can measure illuminance up to a maximum of 1000 lx by connecting the output of the C9329 to a voltmeter in the 1 V range via an external resistive voltage divider.

A standard light source is normally used to calibrate this circuit, but if not available, then a simple calibration can be performed with a 100 W white light source.

To calibrate this circuit, first select the L range on the C9329 and then turn the variable resistor VR clockwise until it stops. Block the light to the S9219 while in this state, and rotate the zero adjusting volume control on the C9329 so that the voltmeter reads 0 mV. Next turn on the white light source, and adjust the distance between the white light source and the S9219 so that the voltmeter display shows 0.225 V. (The illuminance on the S9219 surface at this time is approximately 100 lx .) Then turn the VR counterclockwise until the voltmeter display shows 0.1 V. The calibration is now complete.

After calibration, the output should be 1 mV/ lx in the L range, and 100 mV/ lx in the M range on the C9329.

[Figure 8] Basic illuminometer (1)

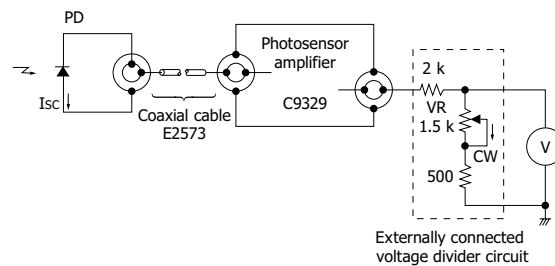

PD: S9219 (4.5 $\mu A/100 lx$)

KSPDC0054EC

» Basic illuminometer (2)

This is an basic illuminometer circuit using a visual-compensated Si photodiode S7686 and an op amp. A maximum of 10000 lx can be measured with a voltmeter having a 1 V range. It is necessary to use a low consumption current type op amp which can operate from a single voltage supply with a low input bias current.

An incandescent lamp of 100 W can be used for approximate calibrations in the same way as shown above "Basic illuminometer (1)". To make calibrations, first select the 10 mV/ lx range and short the wiper terminal of the variable resistor VR and the output terminal of the op amp. Adjust the distance between the photodiode S7686 and the incandescent lamp so that the voltmeter reads 0.45 V. (At this point, illuminance on S7686 surface is about 100 lx .) Then adjust VR so that the voltmeter reads 1.0 V. Calibration has now been completed.

[Figure 9] Basic illuminometer (2)

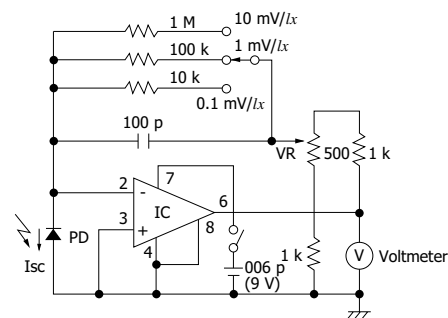

VR: Meter calibration trimmer potentiometer
 IC : TLC271, etc.
 PD: S7686 (0.45 $\mu A/100 lx$)

KPDC0018ED

» Light balance detection circuit

Figure 10 shows a light balance detector circuit utilizing two Si photodiodes PD1 and PD2 connected in reverse-parallel and an op amp current-voltage converter circuit.

The photoelectric sensitivity is determined by the feedback resistance R_f . The output voltage V_o of this circuit is zero if the amount of light entering the two photodiodes PD1 and PD2 is equal. By placing two diodes D in reverse parallel with each other, V_o will be limited range to about $\pm 0.5 V$ in an unbalanced state, so that the region around a balanced state can be detected with high sensitivity. This circuit can be used for light balance detection between two specific wavelengths using optical filters.

[Figure 10] Light balance detection circuit

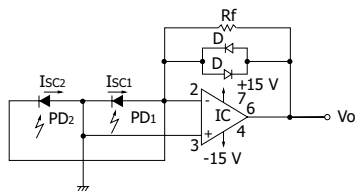

PD: S1226/S1336/S2386 series, etc.
 IC: LF356, etc.
 D: ISS226, etc.

$$V_o = R_f \times (I_{sc2} - I_{sc1}) \text{ [V]}$$

$$(V_o < \pm 0.5 \text{ V})$$

KPDC0017EB

» Light absorption meter

This is a light absorption meter using a dedicated IC and two photodiodes which provides a logarithmic ratio of two current inputs (See Figure 11). By measuring and comparing the light intensity from a light source and the light intensity after transmitting through a sample with two photodiodes, light absorbance by the sample can be measured.

To make measurements, optical system such as the incident aperture should first be adjusted to become the output voltage V_o to 0 V so that the short circuit current from the two Si photodiodes is equal. Next, the sample is placed on the light path of one photodiode. At this point, the output voltage value means the absorbance by the sample. The relationship between the absorbance A and the output voltage V_o can be directly read as $A = -V_o$ [V]. If a filter is interposed before the light source as shown in the figure 11, the absorbance of specific light spectrum or monochromatic light can be measured.

[Figure 11] Light absorption meter

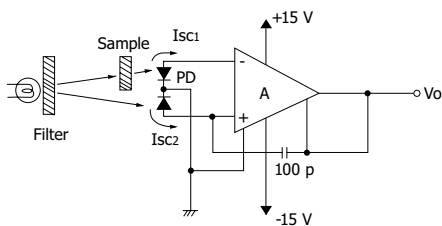

A: Log amp
 PD: S5870, etc.

$$V_o = \log (I_{sc1}/I_{sc2}) \text{ [V]}$$

KPDC0025EC

» Total emission measurement of LED

Since the emitting spectral width of LEDs is usually as narrow as about several-ten nanometers, the amount of the LED emission can be calculated from the Si photodiode photosensitivity at a peak emission wavelength of the LED. In Figure 12, the inner surface of the reflector block B is mirror-processed so that it reflects the light emitted from the side of the LED towards the Si photodiode. Therefore, the total amount of the LED emission can be detected by the Si photodiode.

[Figure 12] Total emission measurement of LED

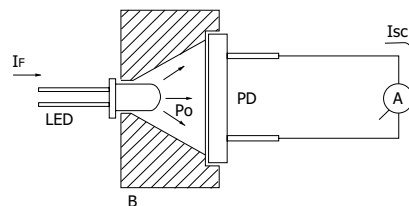

A: Ammeter, 1 mA to 10 mA
 PD: S2387-1010R
 B: Aluminum block, inner Au plating
 S: Photosensitivity of Si photodiode
 Refer to the spectral response chart in the datasheets.
 S2387-1010R: $S \approx 0.58 \text{ A/W}$ ($\lambda = 960 \text{ nm}$)
 Po: Total emission

$$P_o \approx \frac{I_{sc}}{S} \text{ [W]}$$

KPDC0026EA

» High-speed photodetector circuit (1)

The high-speed photodetector circuit shown in Figure 13 utilizes a low-capacitance Si PIN photodiode (with a reverse voltage applied) and a high-speed op amp current-voltage converter circuit. The frequency band of this circuit is limited by the op amp device characteristics to less than about 100 MHz.

When the frequency band exceeds 1 MHz, the lead inductance of each component and stray capacitance from feedback resistance R_f exert drastic effects on device response speed. That effect can be minimized by using chip components to reduce the component lead inductance, and connecting multiple resistors in series to reduce stray capacitance.

The photodiode leads should be kept as short as possible and the pattern wiring to the op amp should be made as short and thick as possible. This will lower effects from the stray capacitance and inductance occurring on the circuit board pattern of the op amp inputs and also alleviate effects from photodiode lead inductance. Moreover, a ground plane structure utilizing copper plating at ground potential across the entire board surface will prove effective in boosting device performance.

A ceramic capacitor should be used as the 0.1 μF capacitor connected to the op amp power line, and the connection to ground should be the minimum direct distance.

Hamamatsu offers C8366 photosensor amplifier for PIN photodiodes with a frequency bandwidth up to 100 MHz.

[Figure 13] High-speed photodetector circuit (1)

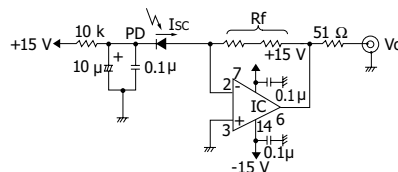

PD: High-speed PIN photodiode (S5971, S5972, S5973, etc.)
 Rf: Two or more resistors are connected in series to eliminate parallel capacitance.
 IC: LT1360, HA2525, etc.

$$V_o = -I_{sc} \times R_f \text{ [V]}$$

KPDC0020EE

[Figure 14] Photosensor amplifier C8366



» High-speed photodetector circuit (2)

The high-speed photodetector circuit in Figure 15 uses load resistance RL to convert the short circuit current from a low-capacitance Si PIN photodiode (with a reverse voltage applied) to a voltage, and amplifies the voltage with a high-speed op amp. There is no problem with gain peaking based due to phase shifts in the op amp. A circuit with a frequency bandwidth higher than 100 MHz can be attained by selecting the correct op amp. Points for caution in the components, pattern and structure are the same as those listed for the "High-speed photodetector circuit (1)".

[Figure 15] High-speed photodetector circuit (2)

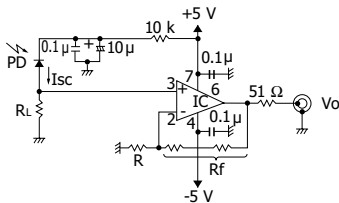

PD : High-speed PIN photodiode (S5971, S5972, S5973, S9055, S9055-01, etc.)
 RL, R, Rf: Determined by recommended conditions of the op amp
 IC : AD8001, etc.

$$Vo = I_{sc} \times R_L \times \left(1 + \frac{R_f}{R}\right) [V]$$

KPDC0015EE

» AC photodetector circuit (1)

The AC photodetector circuit in Figure 16 uses load resistance RL to convert the photocurrent from a low-capacitance Si PIN photodiode (with a reverse voltage applied) to a voltage, and amplifies the voltage with a high-speed op amp. There is no problem with gain peaking based due to phase shifts in the op amp. A circuit with a frequency bandwidth higher than 100 MHz can be attained by selecting the correct op amp. Points for caution in the components, pattern and structure are the same as those listed for the "High-speed photodetector circuit (1)".

[Figure 16] AC photodetector circuit (1)

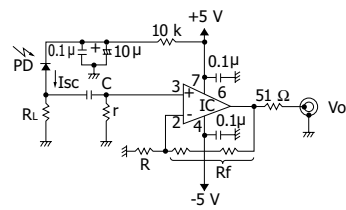

PD : High-speed PIN photodiode (S5971, S5972, S5973, S9055, S9055-01, etc.)
 RL, R, Rf, r: Determined by recommended conditions of the op amp
 IC : AD8001, etc.

$$Vo = I_{sc} \times R_L \times \left(1 + \frac{R_f}{R}\right) [V]$$

KPDC0034EA

» AC photodetector circuit (2)

This AC photodetector circuit utilizes a low capacitance PIN photodiode (with a reverse voltage applied) and a FET serving as a voltage amplifier. Using a low-noise FET allows producing a small yet inexpensive low-noise circuit, which can be used in light sensors for FSO (free space optics) and optical remote controls, etc. In Figure 17 the signal output is taken from the FET drain. However, for interface to a next stage circuit having low input resistance, the signal output can also be taken from the source or a voltage-follower should be added.

[Figure 17] AC photodetector circuit (2)

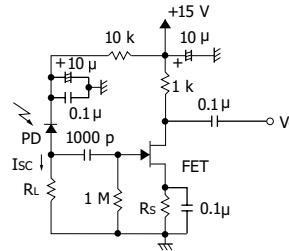

PD : High-speed PIN photodiode (S2506-02, S5971, S5972, S5973, etc.)
 RL : Determined by sensitivity and "time constant of Ct" of photodiode
 Rs : Determined by operation point of FET
 FET: 2SK209, etc.

KPDC0014EF

Архангельск (8182)63-90-72
 Астана (7172)727-132
 Астрахань (8512)99-46-04
 Барнаул (3852)73-04-60
 Белгород (4722)40-23-64
 Брянск (4832)59-03-52
 Владивосток (423)249-28-31
 Волгоград (844)278-03-48
 Вологда (8172)26-41-59
 Воронеж (473)204-51-73
 Екатеринбург (343)384-55-89
 Иваново (4932)77-34-06

Ижевск (3412)26-03-58
 Иркутск (395)279-98-46
 Казань (843)206-01-48
 Калининград (4012)72-03-81
 Калуга (4842)92-23-67
 Кемерово (3842)65-04-62
 Киров (8332)68-02-04
 Краснодар (861)203-40-90
 Красноярск (391)204-63-61
 Курск (4712)77-13-04
 Липецк (4742)52-20-81
 Киргизия (996)312-96-26-47

Магнитогорск (3519)55-03-13
 Москва (495)268-04-70
 Мурманск (8152)59-64-93
 Набережные Челны (8552)20-53-41
 Нижний Новгород (831)429-08-12
 Новокузнецк (3843)20-46-81
 Новосибирск (383)227-86-73
 Омск (3812)21-46-40
 Орел (4862)44-53-42
 Оренбург (3532)37-68-04
 Пенза (8412)22-31-16
 Казахстан (772)734-952-31

Пермь (342)205-81-47
 Ростов-на-Дону (863)308-18-15
 Рязань (4912)46-61-64
 Самара (846)206-03-16
 Санкт-Петербург (812)309-46-40
 Саратов (845)249-38-78
 Севастополь (8692)22-31-93
 Симферополь (3652)67-13-56
 Смоленск (4812)29-41-54
 Сочи (862)225-72-31
 Ставрополь (8652)20-65-13
 Таджикистан (992)427-82-92-69

Сургут (3462)77-98-35
 Тверь (4822)63-31-35
 Томск (3822)98-41-53
 Тула (4872)74-02-29
 Тюмень (3452)66-21-18
 Ульяновск (8422)24-23-59
 Уфа (347)229-48-12
 Хабаровск (4212)92-98-04
 Челябинск (351)202-03-61
 Череповец (8202)49-02-64
 Ярославль (4852)69-52-93